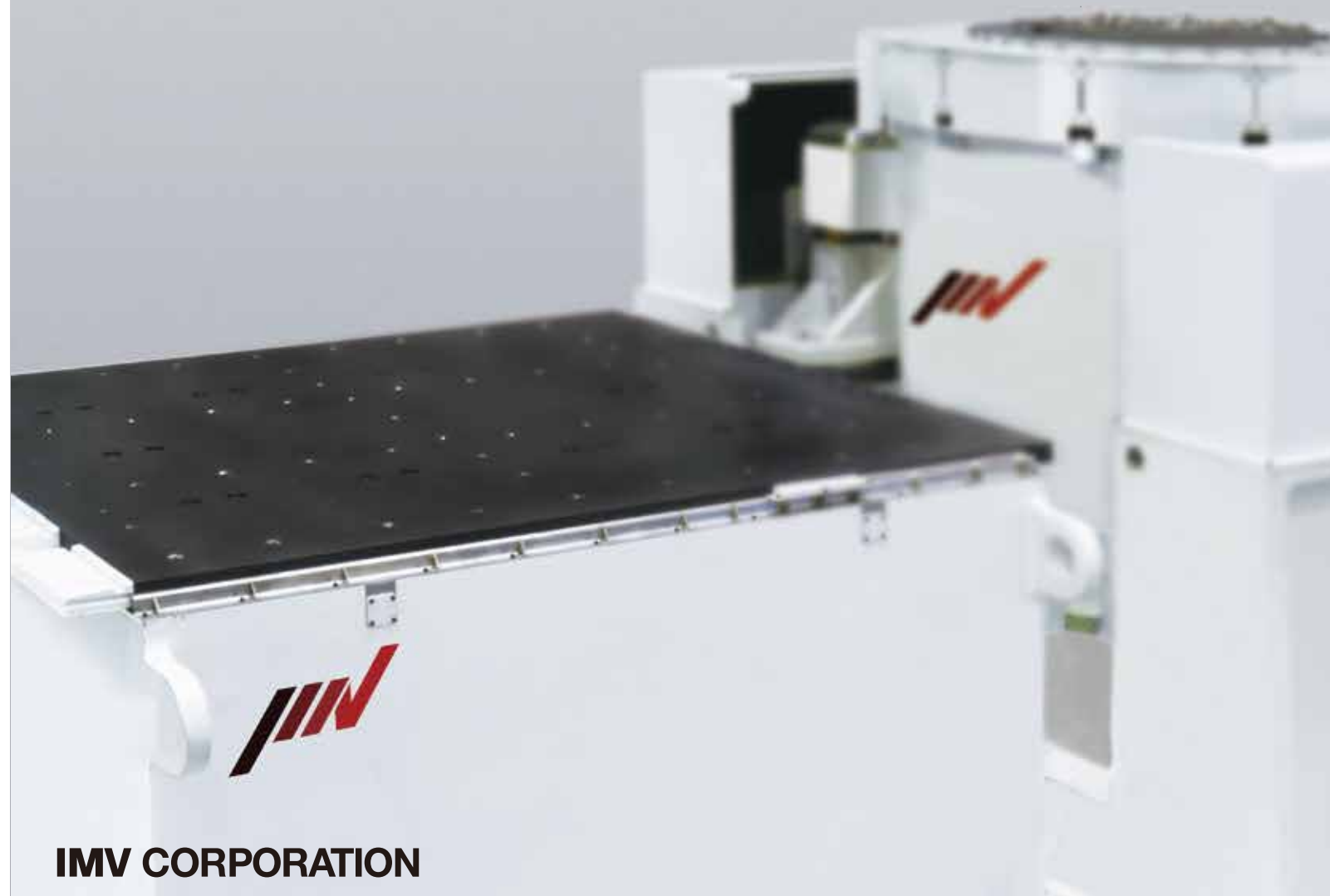




Dynamic Simulation System Full Lineup Catalogue



IMV CORPORATION

Head Office e-mail info-global@imv-corp.com
web <https://we-are-imv.com/en/>

*The specifications and design are subject to change without notice.





World's leading supplier of high reliability vibration test systems

Wide range of industries benefit through quality and reliability improvements

Since it was founded in 1957, IMV has been proud to be at the forefront of research and development in vibration testing systems, supplying technically-advanced systems, with safety and reliability as first priorities.

The range of IMV vibration-test systems includes single-axis and simultaneous multi-axis systems for up to six degrees of freedom simulation. A range of vibration and diagnostic instruments are also available. Engineering consultancy services to assist customers with vibration measurement, analysis and testing can also be provided.

IMV designs, manufactures, markets and maintains vibration test systems which simulate actual vibration environments, and measuring systems which record and analyse vibration created or experienced by a product. IMV can also provide test laboratory and consultancy services.

We are proud to be contributing to the safety and reliability of a wide range of products by working with the automotive, aerospace, electrical machinery and structural engineering industries to solve problems caused by vibration.

Our policy is to continue to develop our skills and products to ensure we continue to provide the best possible service to our clients.



INDEX

Series Arrangements >> P.03

[Basic Systems] Vibration Test Systems

Ecology >> P.07
 High Grade Range A-series >> P.09
 Large Displacement Range J-series >> P.13
 Standard Range i-series >> P.15
 Transportation Test Range C-series >> P.17
 High Excitation Force Water Cooled Range K-series >> P.19
 Low Acoustic Noise and Compact Range m-series >> P.21
 High Frequency and Compact Range VSH/PET >> P.23
 Optional Units >> P.25

[Multi-axis systems] Vibration Test Systems

2-Axis Changeover Systems DC-series >> P.35
 3-Axis Changeover Systems TC-series >> P.36
 2-Axis Simultaneous Systems DS-series >> P.37
 3-Axis Simultaneous Systems TS-series >> P.38
 6 Degrees of Freedom Systems TTS-series >> P.39

[Environmental Test Systems] Vibration Test System

Chamber for Vertical Excitation >> P.42
 Chamber for both Vertical and Horizontal Excitation >> P.43
 Chamber for Multi-Axis Excitation >> P.45
 Prefabricated Chamber for Large Specimens >> P.46
 Climatic Chamber Controllers >> P.47
 Option >> P.48

[Vibration Controller] K2+

Vibration Controller K2+ >> P.50

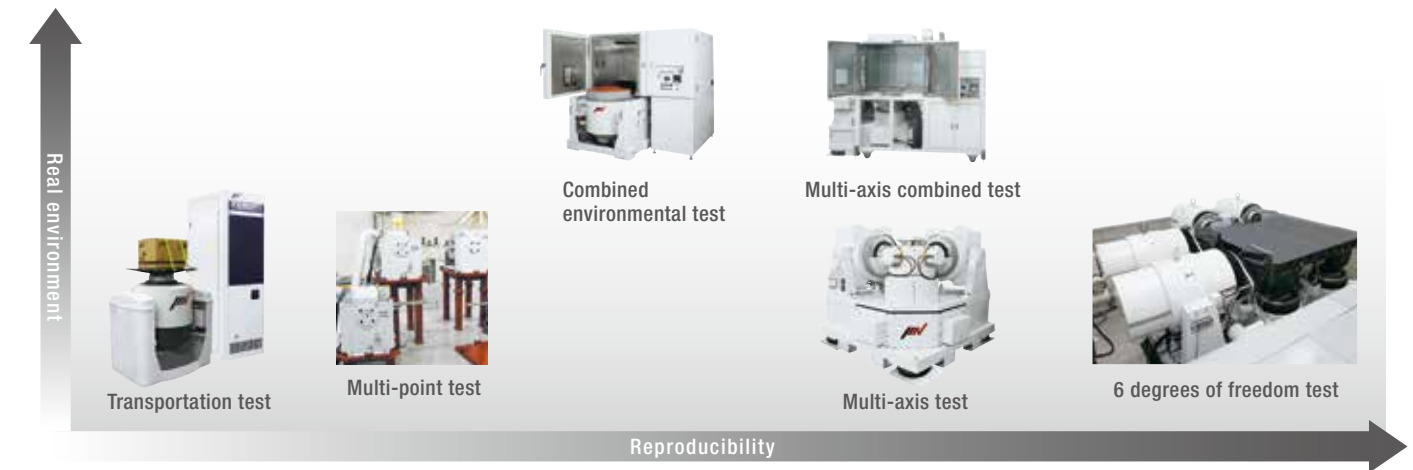
[Case Studies]

Automotive Parts >> P.56
 Electronic Parts >> P.61
 Transportation Test >> P.62
 Construction Machinery >> P.63
 Earthquake Resistance >> P.64
 Aerospace >> P.65
 Other Applications >> P.66

Technical Guidance >> P.67
 Conversion Table >> P.74
 Related Products >> P.75
 Export of Products >> P.76
 IMV Test Lab Network >> P.77
 Coverage >> P.79
 System Layout >> P.80

Series Arrangements

Vibration Test Systems Lineup Chart



	Automotive parts	Aerospace	Electronic parts	Information and telecommunication equipment	Precision equipment	Electrical equipment	Transportation environment	Usage environment		
A-series J-series i-series	High Grade Range Large Displacement Range Standard Range	P09 P13 P15	Car audio, Navigation system, Door mirror, Inverter, Motor, Light associated part, ECU associated part, Solenoid, Car-mounted meter, Electric power station motor, Combination meter, Fuel pump, Inlet system part, Hybrid associated part, Battery, Electric pump, Muffler, Catalyst, Fuel battery, ABS coil, Seat belt, Breaking system	Personal monitor TV, Communications equipment, Resin product, Seal material, Dish, Chair, Aircraft engine component, Space environmental utilization, Airborne equipment	LCD TV, Connector component, Car mounted electric component, General purpose motor, In-rack equipment, PC, Printed circuit board, Impact from transportation equipment	Navigation system, Car mounted telecommunication equipment, Vending machine on the expressway, Industrial motor, Antenna associated component, Large antenna	Industrial robot, Digital camera, Lens, Optical equipment, Surface mounter associated component, Mobile phone, Copy machine, Video camera	Withstanding voltage transformer, Fuel battery, Inverter associated component, Space battery, Large lithium battery	Rail vehicle component, Construction equipment, Shipping on a rough road	Combination meter, Instrumental panel associated component, Solar system, Other car-mounted component, PC
C-series	Transportation Test Range	P17	Door mirror	_____	Packing material, Transportation package, Usage environmental transportation, Domestic electric appliances, Projector	Packing material	Packing material, Transportation package, Usage environmental transportation, Game equipment	Inverter equipment	Transportation for medicine	Packing material
K-series	High Excitation Force Water Cooled Range	P19	Brake, Catalyst, Heat insulation, Hydraulic sensor, Starter, alternator, Muffler, Hybrid motor, Battery, Sensor, Dynamo, Power unit	Satellite equipment, Propeller engine	Servomotor, Refrigerator, Heater, Washing machine, Major electronics	Large parabolic antenna, Antenna associated component	_____	Large battery equipment	Rail vehicle component, Railway component	Display
m-series	Low Acoustic Noise and Compact Range	P21	Air-conditioner vent, ETC, ITS device, Car-mounted sensor, Car audio, Navigation system	_____	Board, Mobile phone, Mobile products, Electronic component, Compact motor	ETC for motorcycle, Mobile phone	Medical equipment, Usage board, Digital camera, Semiconductor component	_____	_____	Structure(miniature)
VSH/PET	High Frequency and Compact Range	P23	O ₂ sensor, Exhaust sensor	_____	Filling, Piezo-electric element, Sensor associated component, SW associated component	_____	_____	_____	_____	_____
DC-series	2-Axis Changeover Systems	P35	Radiator, Car air-conditioner module, Compressor	Aviation communication equipment, Aircraft component	Real environmental shipping, Car audio, LCD panel, Domestic electric appliances	Car navigation, Car audio, Bracket	Video camera, Car audio, Copy machine, Multi-function printer	Large battery equipment, Power board, Control board	Cushioning material, Packing material, Transportation equipment	Earthquake simulation system, Earthquake resistance test system
TC-series	3-Axis Changeover Systems	P36	Radiator, Car air-conditioner module							
DS-series	2-Axis Simultaneous Systems	P37	Radiator, Car air-conditioner module, Back mirror							
TS-series	3-Axis Simultaneous Systems	P38	Car audio, Navigation system, Car navigation system, Air-conditioner, Vibration insulation mount, Radiator							
TTS-series	6 Degrees of Freedom Systems	P39	Ride quality, Construction equipment, Cutaway body	_____	_____	_____	_____	Battery	_____	Cabin for construction equipment

Vibration Test Systems

Basic Systems

High Grade Range	A-series	» P.09
Large Displacement Range	J-series	» P.13
Standard Range	i-series	» P.15
Transportation Test Range	C-series	» P.17
High Excitation Force Water Cooled Range	K-series	» P.19
Low Acoustic Noise and Compact Range	m-series	» P.21
High Frequency and Compact Range	VSH/PET	» P.23
Optional Units		» P.25

Approach to low noise

Careful attention to the design of the top cover using airflow modeling reduces the air velocity and the resulting acoustic noise.



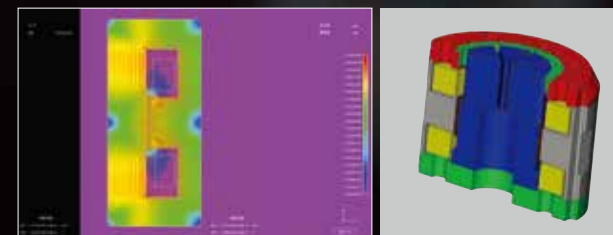
Upper (armature) support system PS Guide

High vibration levels intensity places extreme stress on the main parts of the vibration generator. The Parallel Slope Guide (PSG) uses a patented design to achieve a highly durable armature support which also gives excellent performance. The design provides sufficient stiffness to cross-axis forces and produces low distortion at all levels of vibration.



One of the world's largest class air-cooled shaker systems

By taking advantage of the latest finite-element analysis tools, the magnetic circuit and cooling designs used in the IMV air-cooled range enable higher force ratings (to 74 kN) to be achieved. Air-cooled systems are lower cost both to install and to maintain compared to water-cooled systems.



Simple confirmation of reduction of CO₂ and electricity consumption

When combined with the IMV 'K2' vibration controller, the ECO-shaker system computes and displays electricity savings in real-time. A report of energy consumption can be produced after each test.



Energy-saving results screen

Ecology

Environmentally-friendly vibration systems

Automatic energy saving

ECO-shaker is an electrodynamic vibration test system in which the output of the power amplifier, power input to the vibration generator and cooling blower speed are automatically optimised, according to the payload and test requirements.

Complicated manual settings are no longer needed.

Changes in the operating environment or in test level are accommodated without operator intervention.

[Features]

- Only vibration test pattern need to be set
- Automatic response to changes in sample under test or test level
- Continuous monitoring of temperatures used to control blower speed

*Operation condition selection system and method (JP Patent No. 4231095)
*Operation condition selection system and program (JP Patent No. 4263229)



Vibration controller K2+

Effect of energy saving

The lower the system output, the more energy saving can be achieved.

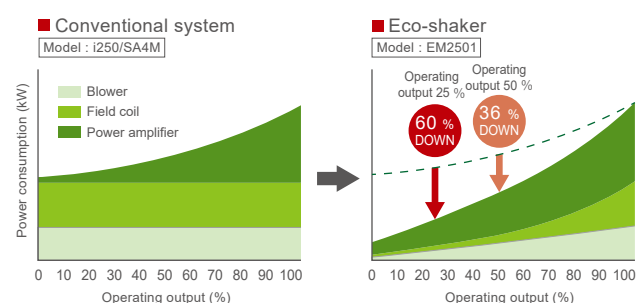
Calculation method Calculation of CO₂ reduction, referring to actual data of our i250/SA4M (Maximum force 32 kN)

Conditions 1) Random 2) Average operating output: 25 %
3) Average operating ratio per year: 70 %

*Results may vary for systems, test conditions and cases.

Save up to **80 %** on your running costs

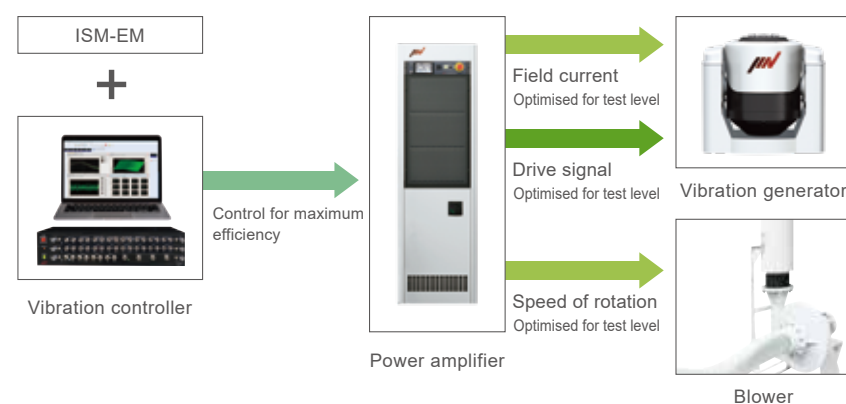
Reduce your CO₂ emissions by up to **80 %**



Comparison of power consumption with the conventional system

Operation of ISM-EM (Power consumption)

Minimising the energy consumption of a conventional vibration test system would require complex calculation and adjustments to suit the test requirements. The Integrated Shaker Manager (ISM-EM) technology incorporated within the ECO-shaker system automatically controls the power amplifier output, field level and blower speed to achieve the maximum efficiency under all test conditions.



Upgrading existing systems

ISM-EM technology can be added to existing IMV vibration test systems by installing the ISM-EM module and additional software. Contact IMV or your local distributor for further information and delivery.



Existing system

ISM-EM unit

Example design

Improvement of working conditions

Ensuring the vibration system is operating efficiently not only saves money; it also can reduce noise levels and heat dissipation into the workplace. This improves the working environment and can simplify initial installation.

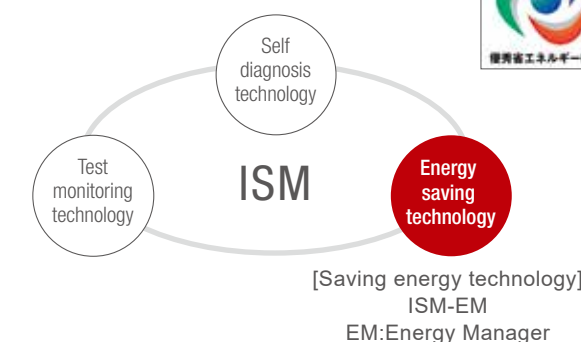


Blower

Energy saving type vibration test system [ECO-Shaker]

Vibration test systems consume a lot of electricity. IMV has developed environmentally friendly products which minimise the required electric power and cut down electric consumption and CO₂ emissions. Due to the great contribution to the promotion of efficient use of energy, the technology of ECO-Shaker received the Chairman's award from The Machinery Federation in 2012.

Intelligent Shaker Manager



Contribution to the environment

Many countries have legislated, such as the Clean Development Mechanism in the Kyoto Protocol, and the EU Energy Efficiency Directive, obliging businesses and their products to be more energy-efficient. The IMV ECO-shaker systems help to meet these regulations.



A-series

High Grade Range



A30/EM3HAG

A new standard created by listening to our customers.

A wider range of test requirements and higher test specifications.
 A-series meets the needs for such a versatile test environment.
 Advanced automatic energy saving, high level of functionality and a protected test environment.
 A-series improves the working environment of vibration testing.

- [Improvement of performance]
- [User friendly and Secure]
- [User first principle]

Improvement of performance

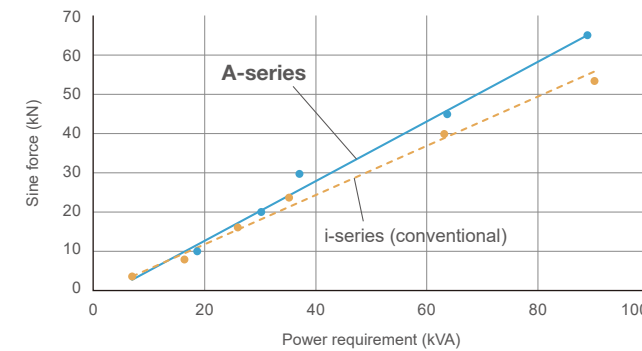
A-series meets the demand

A wider range of test requirements and higher test specifications.
 A-series meets the needs for such a versatile test environment.

■ Improvement in excitation force

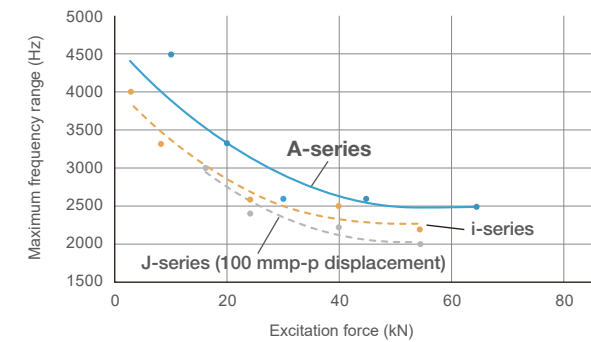
When compared with the conventional i- & J-series, the A-series has increased relative excitation force.

- Increased force per system power requirement
- Increased force per system mass
- Increased force per system size



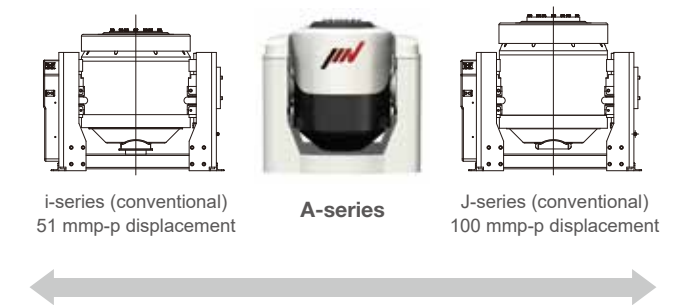
■ Increase in frequency range

In addition to the increased displacement of 76.2 mmp-p, the maximum frequency range is also increased when compared to the i-, and J-series.



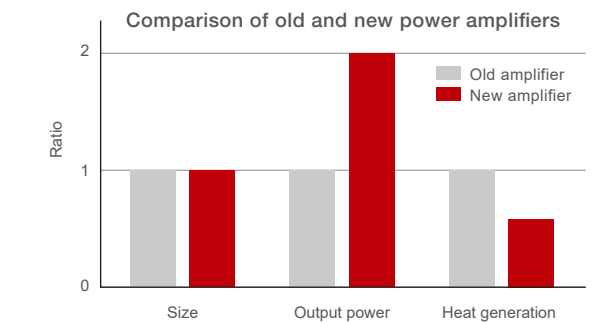
■ Standard 76.2 mmp-p displacement *Only for A30, A45, A65, A74

A-series has a displacement of 76.2 mmp-p (3-inch stroke), which provides a good balance within the specifications for velocity, acceleration and displacement.
 This single system can be used for a very wide variety of tests.



■ Introduction of new power module

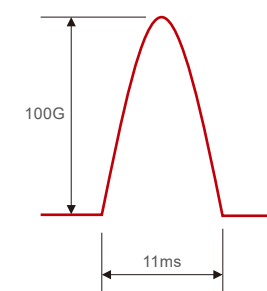
By developing a power amplifier that uses a new next generation Silicon Carbide power module, IMV has achieved low noise and high efficiency.
 This new power module is standard-issue for all A-series models.



■ High velocity shock testing

Where a test requires a high shock velocity, traditional shaker systems use a matching transformer to achieve the necessary higher armature voltage. Since IMV's ECO-system has complete control over the field level, the field value can be adjusted to increase the maximum shock velocity capability of the system. By entering the specified shock profile into IMV's K2 controller. The field level in the shaker is automatically adjusted to ensure that the required velocity is achieved. A-series (EM amplifier model) provides a maximum of 3.5 m/s shock velocity testing.

Examples of shock test



Series	Model	i220/SA1HAG					
		Rated Force Shock (kN)	Maximum Velocity Shock (m/s peak)	Maximum Displacement (mmp-p)	Maximum Load (kg)	Not achievable (not enough velocity and displacement)	
i-series (conventional)	Rated Force Shock (kN)	16					
	Maximum Velocity Shock (m/s peak)	2.2					
	Maximum Displacement (mmp-p)	51					
	Maximum Load (kg)	Not achievable (not enough velocity and displacement)					
Series	Model	No applicable product	J230/SA3HAG	J240/SA4HAG	J250/SA6HAG	J260/SA7HAG	No applicable product
		Rated Force Shock (kN)	—	40	55	80	108
J-series (conventional)	Maximum Velocity Shock (m/s peak)	—	2.4	2.4	2.4	2.4	—
	Maximum Displacement (mmp-p)	—	100	100	100	100	—
	Maximum Load (kg)	—	Not achievable (not enough velocity)				—
Series	Model	A11/EM1HAG	A22/EM2HAG	A30/EM3HAG	A45/EM4HAG	A65/EM5HAG	A74/EM8HAG
		Rated Force Shock (kN)	22 (16.5)	44 (36)	60 (50)	90 (80)	130 (120)
A-series	Maximum Velocity Shock (m/s peak)	2.5 (3.5)	2.5 (3.5)	2.5 (3.5)	2.5 (3.5)	2.5 (3.5)	2.5 (3.5)
	Maximum Displacement (mmp-p)	51 (55)	51 (55)	76.2	76.2	76.2	76.2
	Maximum Load (kg)*	5	14	17	30	48	86

*Maximum load on bare table

User friendly and Secure

A-series changes

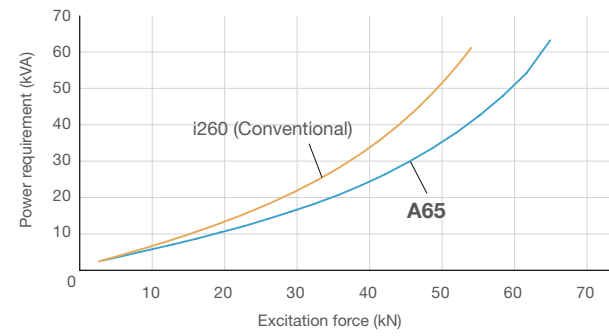
Advanced automatic energy saving, high level of functionality and a protected test environment.

A-series improves the working environment of vibration testing.

Lower power consumption

In comparison with the same class of conventional systems (i, J-series), the A-series achieves lower power consumption. With an automatic energy-saving function, increased energy saving is achieved across all force ranges.

Comparison of consumed power per excitation force A65 vs i260



International safety standards

A-series complies with international safety standards.



Optional built-in vibration controller

*Only for A12, A22, C10

It is possible to save the space by incorporating PC, display and keyboard for vibration controller into the power amplifier.

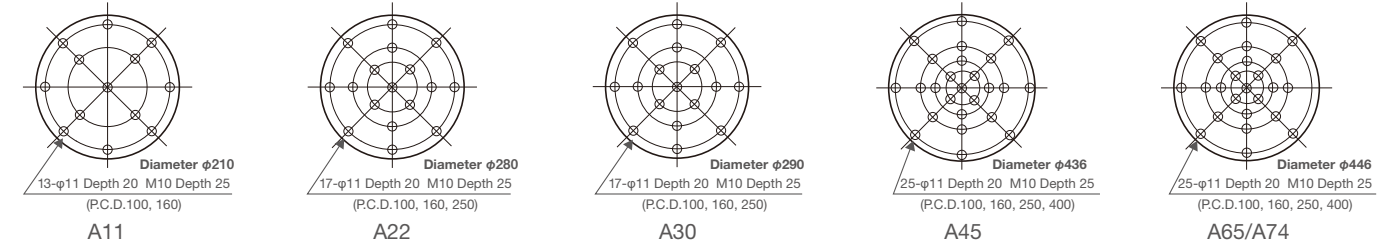
The keyboard can be stored when it is not used.

*Display size is 17 inch

*Keyboard with numeric keypad



Table Insert Pattern (Unit: mm)



Specifications

System Model		A11/SA1HAG	A11/EM1HAG	A22/SA2HAG	A22/EM2HAG	A30/SA3HAG	A30/EM3HAG	A45/SA4HAG	A45/EM4HAG	A65/SA5HAG ⁸	A65/EM5HAG ⁸	A74/EM6HAG ⁸	A74/EM8HAG ⁸	
System Specifications	Frequency Range (Hz)	0-4500 ⁵		0-3300		0-2600		0-2600		0-2600 ⁶		0-2600 ⁶		
	Rated Force	Sine (kN)	11	11	22	22	30	30	45	45	65	65	74	74
		Random (kN rms) ¹	11	11	22	22	30	30	45	45	65	65	74	74
		Shock (kN)	22	22	44	44	60	60	90	90	130	130	148	180
		High Velocity Shock (kN)	-	16.5	-	36	-	50	-	80	-	120	120	160
	Maximum Acc.	Sine (m/s ²)	1000	1000	1000	1000	900	900	900	900	900	900	1000	1000
		Random (m/s ² rms)	630	630	630	630	630	630	630	630	630	630	630	630
		Shock (m/s ² peak)	2000	2000	2000	2000	1818	1818	1800	1800	1806	1806	2000	2000
		High Velocity Shock (m/s ² peak)	-	1500	-	1636	-	1515	-	1600	-	1666	1621	2000
	Maximum Vel.	Sine (m/s)	2.0	2.0	2.0	2.0	2.0	2.0	2.0	2.0	2.0	2.0	2.0	2.0
		Shock (m/s peak)	2.5	2.5	2.5	2.5	2.5	2.5	2.5	2.5	2.5	2.5	2.5	2.5
	Maximum Disp.	Sine (mmp-p)	51	51	51	51	76.2	76.2	76.2	76.2	76.2	76.2	76.2	76.2
		High Velocity Shock (mmp-p)	-	55	-	55	-	76.2	-	76.2	-	76.2	76.2	76.2
	Maximum Travel (mmp-p)		64	64	64	64	82	82	82	82	82	82	82	82
	Maximum Load (kg)		200	200	300	300	400	400	600	600	1000	1000	1000	1000
Power Requirements (kVA) ²		20.4	20.4	30	30	36	36	57	57	83	83	118	118	
Breaker Capacity (A)		75 ³	75 ³	100 ³	100 ³	125 ³	125 ³	200 ³	200 ³	300 ³	300 ³	250 ³	250 ³	
Vibration Generator	Model	A11	A11	A22	A22	A30	A30	A45	A45	A65	A65	A74	A74	
	Armature Mass (kg)	11	11	22	22	33	33	50	50	72	72	74	74	
	Armature Diameter (φmm)	210	210	280	280	290	290	436	436	446	446	446	446	
	Allowable Eccentric Moment (N·m)	294	294	700	700	850	850	1550	1550	1550	1550	1550	1550	
	Dimensions (mm) W x H x D	946 x 827 x 676	946 x 827 x 676	1038 x 955 x 775	1038 x 955 x 775	1100 x 1048 x 840	1100 x 1048 x 840	1232 x 1215 x 1040	1232 x 1215 x 1040	1310 x 1253 x 1040	1310 x 1253 x 1040	1310 x 1253 x 1040	1310 x 1253 x 1040	
	Shaker Body Diameter (φmm)	585	585	678	678	725	725	825	825	925	925	925	925	
	Mass (kg)	1080	1080	1600	1600	2100	2100	3200	3200	4200	4200	4200	4200	
Power Amplifier	Model	SA1HAG-A11	EM1HAG-A11	SA2HAG-A22	EM2HAG-A22	SA3HAG-A30	EM3HAG-A30	SA4HAG-A45	EM4HAG-A45	SA5HAG-A65	EM5HAG-A65	EM6HAG-A74	EM8HAG-A74	
	Maximum Output (kVA)	12	12	24	24	31	31	44	44	68	68	100	100	
	Dimensions (mm) W x H x D	580 x 1950 x 850	580 x 1950 x 850	580 x 1950 x 850	580 x 1950 x 850	580 x 1950 x 850	580 x 1950 x 850	580 x 1950 x 850	580 x 1950 x 850	580 x 1950 x 850	580 x 1950 x 850	1160 x 1950 x 850	1160 x 1950 x 850	
Mass (kg)	280	470	350	560	520	590	900	1000	1000	1150	1340	1850		
Controller	Vibration Controller	See Vibration Controller K2												
	Cooling Method	Air cooling												
Cooling	Blower	Dimensions (mm)	606 x 1315 x 891	708 x 1421 x 782	707 x 1531 x 917	707 x 1531 x 917	707 x 1531 x 917	707 x 1531 x 917	1057 x 1841 x 1125	1169 x 2123 x 799	1214 x 2006 x 1124	1128 x 2380 x 899	1462 x 2800 x 927	1462 x 2800 x 927
		W x H x D ⁷												
		Mass (kg)	125	140	210	210	210	210	250	280	420	228	536	536
		Wattage (kw)	3.7	3.7	5.5	5.5	5.5	5.5	11	11	18.5	18.5	30	30
Duct Hose Diameter (φ)	125	125	200	200	200	200	250	250	250	250	250	250	250	

¹ Random force ratings are specified in accordance with ISO5344 conditions. Please contact IMV or your local distributor with specific test requirements.

² Power supply: 3-phase 200/220/380/400/415 V (A74 is only AC380/400/415 V), 50/60 Hz. A transformer is required for other supply voltages.

³ Breaker capacity for AC200 V.

⁴ Breaker capacity for AC400 V.

⁵ Above 4000 Hz, the force rolls-off at a rate of -6 dB/oct.

⁶ Above 2000 Hz, the force rolls-off at a rate of -12 dB/oct.

⁷ Specification above applies to 60 Hz. Dimensions change for 50 Hz.

⁸ An export license is required for exporting the shaker system of over 50 kN sine force. (see P.76)

The specification shows the maximum system performance. For long-duration tests, system must be de-rated up to 70%. Continuous use at maximum levels may cause failure. Please contact IMV if your system operates at more than 70%.

*For random vibration tests, please set the test definition of the peak value of acceleration waveform to operate at less than the maximum acceleration of shock.

*Frequency range values vary according to the sensor and vibration controller.

*Armature mass and acceleration may change when a chamber is added.

*Mass and dimensions may change for CE-marked systems.

J-series

Large Displacement Range



J240/SA4HAG
(With a slip table)

J-series accommodates high velocity and large displacement testing

Long duration shock tests require high velocity and large displacement.

J-series is a high-functionality system that offers usability and durability furnished with functions that accommodate high velocity and large displacement testing.

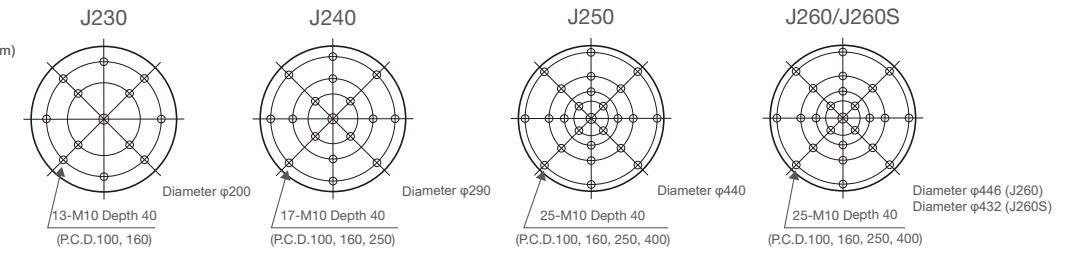
[Expanded maximum test range] • Maximum velocity of Sine force: 2.4 m/s • Maximum velocity of Shock force: 4.6 m/s • Maximum displacement: 100 mmp-p

[Patented upper (armature) support system PS Guide] Parallel Slope Guide is standard

[Low noise] Optimised design of the air intake based on fluid dynamics has reduced the air-intake noise.

[All models can be directly coupled to a climatic chamber]

■ Table Insert Pattern (Unit: mm)



■ Specifications

System Model		J230/SA3HAG	J230S/SA7HAG	J240/SA4HAG	J240/SA6HAG	J250/SA5HAG	J250/SA6HAG	J260/SA7HAG ^{6*}	J260S/SA16HAG ^{6*}	
System Specifications	Frequency Range (Hz)	0-3000	0-3000	0-2400	0-2400	0-2200	0-2200	0-2600 ^{4*}	0-2000	
	Rated Force	Sine (kN)	16	16	24	24	35	40	54	54
		Random (kN rms) ^{1*}	16	16	24	24	35	40	54	54
		Shock (kN)	40	40	55	70	70	80	108	196
	Maximum Acc.	Sine (m/s ²)	941	888	923	923	777	888	857	857
		Random (m/s ² rms)	658	622	646	646	544	622	600	600
		Shock (m/s ² peak)	2000	2000	2000	2000	1555	1777	1714	2000
	Maximum Vel.	Sine (m/s)	2.4	2.4	2.4	2.4	2.4	2.4	2.4	2.4
		Shock (m/s peak)	2.4	3.5	2.4	3.6	2.4	2.4	2.4	4.6
		High Velocity Shock (m/s peak) ^{7*}	3.5	3.5	3.5	3.5	3.5	3.5	3.5	3.5
	Maximum Disp.	Sine (mmp-p)	100	100	100	100	100	100	100	100
		High Velocity Shock (mmp-p) ^{7*}	100	100	100	100	100	100	100	100
		Maximum Travel (mmp-p)	120	120	120	120	120	120	116	116
	Maximum Load (kg)	300	300	400	400	600	600	1000	1000	
Power Requirements (kVA) ^{2*}	28	38	38	52	53	57	86	96		
Breaker Capacity (A) ^{3*}	100	150	150	200	200	200	300	500		
Model		J230	J230S	J240	J240	J250	J250	J260	J260S	
Vibration Generator	Armature Mass (kg)	17	18	26	26	45	45	63	63	
	Armature Diameter (φmm)	200	200	290	290	440	440	446	432	
	Allowable Eccentric Moment (N·m)	700	700	850	850	1550	1550	1550	1550	
	Dimensions (mm) W×H×D	1124×1079×850	1124×1079×850	1234×1145×890	1234×1145×890	1463×1301×1100	1463×1301×1100	1527×1319×1100	1632×1388×1130	
	Shaker Body Diameter (φmm)	630	630	720	720	860	860	920	920	
	Mass (kg)	1800	1800	2400	2400	3500	3500	4100	5000	
Power Amplifier	Model	SA3HAG-J30	SA7HAG-J30S	SA4HAG-J40	SA6HAG-J40	SA5HAG-J50	SA6HAG-J50	SA7HAG-J60	SA16HAG-J60S	
	Maximum Output (kVA)	23	30	34	40	50	57	70	76	
	Dimensions (mm) W×H×D	580×1750×850	580×1950×850	580×1750×850	1160×1950×850	580×1950×850	580×1950×850	580×1950×850	1740×1950×850	
Mass (kg)	330	500	440	1200	880	910	1000	2400		
Controller	Vibration Controller	See Vibration Controller K2								
	Cooling Method	Air cooling								
Cooling	Blower	Dimensions (mm) W×H×D ⁵	606×1315×891	606×1315×891	707×1531×917	707×1531×917	1057×1841×1125	1057×1841×1125	1328×2410×1097	1328×2410×1097
		Mass (kg)	125	125	210	210	250	250	370	370
		Wattage (kw)	3.7	3.7	5.5	5.5	11	11	15	15
		Duct Hose Diameter (φ)	200	200	200	200	250	250	250	250

■ Eco Specifications

System Model		J230/EM3HAG	J240/EM4HAG	J250/EM5HAG	J250/EM6HAG	J260/EM7HAG ^{6*}	
System Specifications	Frequency Range (Hz)	0-3000	0-2400	0-2200	0-2200	0-2600 ^{4*}	
	Rated Force	Sine (kN)	16	24	35	40	54
		Random (kN rms) ^{1*}	16	24	35	40	54
		Shock (kN)	40	55	70	80	108
	Maximum Acc.	Sine (m/s ²)	941	923	777	888	857
		Random (m/s ² rms)	658	646	544	622	600
		Shock (m/s ² peak)	2000	2000	1555	1777	1714
	Maximum Vel.	Sine (m/s)	2.4	2.4	2.4	2.4	2.4
		Shock (m/s peak)	2.4	2.4	2.4	2.4	2.4
		High Velocity Shock (m/s peak) ^{7*}	3.5	3.5	3.5	3.5	3.5
	Maximum Disp.	Sine (mmp-p)	100	100	100	100	100
		High Velocity Shock (mmp-p) ^{7*}	100	100	100	100	100
		Maximum Travel (mmp-p)	120	120	120	120	116
	Maximum Load (kg)	300	400	600	600	1000	
Power Requirements (kVA) ^{2*}	28	38	53	57	86		
Breaker Capacity (A) ^{3*}	100	150	200	200	300		
Model		J230	J240	J250	J250	J260	
Vibration Generator	Armature Mass (kg)	17	26	45	45	63	
	Armature Diameter (φmm)	200	290	440	440	446	
	Allowable Eccentric Moment (N·m)	700	850	1550	1550	1550	
	Dimensions (mm) W×H×D	1124×1079×850	1234×1145×890	1463×1301×1100	1463×1301×1100	1527×1319×1100	
	Shaker Body Diameter (φmm)	630	720	860	860	920	
	Mass (kg)	1800	2400	3500	3500	4100	
Power Amplifier	Model	EM3HAG-J30	EM4HAG-J40	EM5HAG-J50	EM6HAG-J50	EM7HAG-J60	
	Maximum Output (kVA)	23	34	50	57	70	
	Dimensions (mm) W×H×D	580×1750×850	580×1750×850	580×2100×850	580×2100×850	1160×1950×850	
Mass (kg)	380	490	930	960	1400		
Controller	Vibration Controller	See Vibration Controller K2					
	Cooling Method	Air cooling					
Cooling	Blower	Dimensions (mm) W×H×D ⁵	708×1421×782	707×1531×917	1169×2123×799	1169×2123×799	1328×2410×1097
		Mass (kg)	140	210	280	280	370
		Wattage (kw)	3.7	5.5	11	11	15
		Duct Hose Diameter (φ)	200	200	250	250	250

¹ Random force ratings are specified in accordance with ISO5344 conditions. Please contact IMV or your local distributor with specific test requirements. ² Power supply: 3-phase 200/220/240/380/400/415 V, 50/60 Hz. A transformer is required for other supply voltages. ³ Breaker capacity for 200 V. ⁴ Above 2000 Hz, the force rolls-off at a rate of -12 dB/oct. ⁵ Specification above applies to 60 Hz. Dimensions change for 50 Hz. ⁶ An export license is required for exporting the shaker system of over 50 kN sine force. (See P. 76) ⁷ For high velocity option. *The specification shows the maximum system performance. For long-duration tests, system must be de-rated up to 70%. Continuous use at maximum levels may cause failure. Please contact IMV if your system operates at more than 70%. *For random vibration tests, please set the test definition of the peak value of acceleration waveform to operate at less than the maximum acceleration of shock. *Frequency range values vary according to the sensor and vibration controller. *Armature mass and acceleration may change when a chamber is added. *Mass and dimensions may change for CE-marked systems.

i-series

Standard Range



Universally applicable with over 15 years of sales success.

The i-series is a standard range and easier to maintain than custom products.

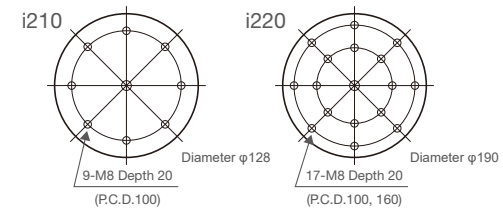
[Maximum test range]

• Maximum acceleration: 1250 m/s² • Maximum velocity: 3.5 m/s • Maximum displacement: 51 mmp-p • Maximum loading mass: 200 kg

[Patented upper (armature) support system PS Guide] Parallel Slope Guide is standard

[All models can be directly paired with a climatic chamber.]

■ Table Insert Pattern (Unit: mm)



■ Specifications

System Model		i210/SA1HAG	i220/SA1HAG	
System Specifications	Frequency Range (Hz)	0-4000	0-3300	
	Rated Force	Sine (kN)	3	8
		Random (kN rms)*1	3	8
		Shock (kN)	9	16
	Maximum Acc.	Sine (m/s ²)	1000	1250
		Random (m/s ² rms)	700	875
		Shock (m/s ² peak)	2000	2000
	Maximum Vel.	Sine (m/s)	2.2	2.2
		Shock (m/s peak)	2.2	2.2
	Maximum Disp.	Sine (mmp-p)	30	51
Maximum Travel (mmp-p)		40	60	
Maximum Load (kg)		120	200	
Power Requirements (kVA)*2		6.8	16.4	
Breaker Capacity (A)*3		30	60	
Vibration Generator	Model	i210	i220	
	Armature Mass (kg)	3	6.4	
	Armature Diameter (φmm)	128	190	
	Allowable Eccentric Moment (N·m)	160	294	
	Dimensions (mm) W × H × D	868 × 700 × 458	1020 × 903 × 550	
	Shaker Body Diameter (φmm)	458	550	
	Mass (kg)	350	900	
Power Amplifier	Model	SA1HAG-i10	SA1HAG-i20	
	Maximum Output (kVA)	5	10	
	Dimensions (mm) W × H × D	580 × 1750 × 850	580 × 1750 × 850	
Controller	Vibration Controller	See Vibration Controller K2		
	Cooling Method	Air cooling		
Cooling	Blower	Dimensions (mm) W × H × D*4	386 × 882 × 369	492 × 1128 × 625
		Mass (kg)	22	70
		Wattage (kw)	0.4	1.5
		Duct Hose Diameter (φ)	125	125

■ Eco Specifications

System Model		i220/EM1HAG	
System Specifications	Frequency Range (Hz)	0-3300	
	Rated Force	Sine (kN)	8
		Random (kN rms)*1	8
		Shock (kN)	16
	Maximum Acc.	High Velocity Shock (kN)*5	10
		Sine (m/s ²)	1250
		Random (m/s ² rms)	875
		Shock (m/s ² peak)	2000
	Maximum Vel.	High Velocity Shock (m/s ² peak)*5	1562
		Sine (m/s)	2.2
Shock (m/s peak)		2.2	
Maximum Disp.	High Velocity Shock (m/s peak)*5	3.5	
	Sine (mmp-p)	51	
Maximum Travel (mmp-p)	High Velocity Shock (mmp-p)*5	51	
Maximum Load (kg)		60	
Power Requirements (kVA)*2		200	
Breaker Capacity (A)*3		16.4	
Vibration Generator	Model	i220	
	Armature Mass (kg)	6.4	
	Armature Diameter (φmm)	190	
	Allowable Eccentric Moment (N·m)	294	
	Dimensions (mm) W × H × D	1020 × 903 × 550	
	Mass (kg)	900	
Power Amplifier	Model	EM1HAG-i20	
	Maximum Output (kVA)	10	
	Dimensions (mm) W × H × D	580 × 1750 × 850	
Controller	Vibration Controller	See Vibration Controller K2	
	Cooling Method	Air cooling	
Cooling	Blower	Dimensions (mm) W × H × D*4	492 × 1128 × 625
		Mass (kg)	70
		Wattage (kw)	1.5
		Duct Hose Diameter (φ)	125

*1 Random force ratings are specified in accordance with ISO5344 conditions. Please contact IMV or your local distributor with specific test requirements. *2 Power supply: 3-phase 200/220/380/400/415 V, 50/60 Hz. A transformer is required for other supply voltages. *3 Breaker capacity for 200 V. *4 Specification above applies to 60 Hz. Dimensions change for 50 Hz. *5 For high velocity option
*The specification shows the maximum system performance. For long-duration tests, system must be de-rated up to 70%. Continuous use at maximum levels may cause failure. Please contact IMV if your system operates at more than 70%. *For random vibration tests, please set the test definition of the peak value of acceleration waveform to operate at less than the maximum acceleration of shock. *Frequency range values vary according to the sensor and vibration controller. *Armature mass and acceleration may change when a chamber is added. *Mass and dimensions may change for CE-marked systems.

C-series

Transportation Test Range



C10/SA1HAG

Large displacement is ideal for heavy weight transportation testing.

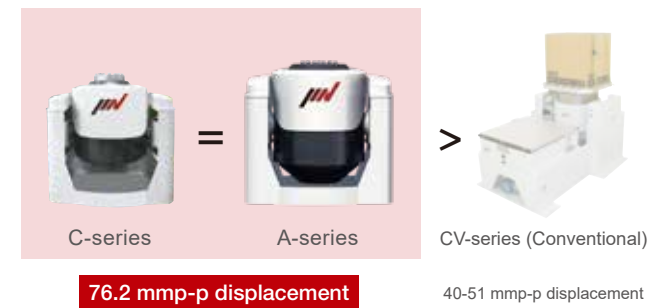
C-series is optimized for transportation tests.

[Heavy weight load] The improved load capacity realizes vibration testing with heavy weight specimen.

[Large maximum displacement] C-series is suitable for low-frequency, high-displacement tests commonly used in transport vibration testing.

Standard 76.2 mmp-p displacement

C-series has a displacement of 76.2 mmp-p (3 inch stroke).



Maximum load 1,000 kg

C-series vibration generators are enhanced for the maximum allowable payload surpassing the conventional. It enables them to perform vibration testing for heavier specimens.



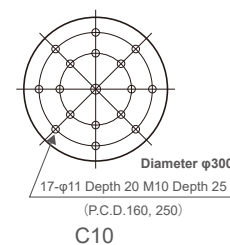
High rigidity

C-series vibration generators are designed to support specimens whose center of gravities are high or deviated from the center lines.

* Please refer to page 73 for allowable eccentric moment.



Table Insert Pattern (Unit: mm)



Specifications

System Model		C10/SA1HAG	Model		SA1HAG-C10		
System Specifications	Frequency Range (Hz)	0-2000	Power Amplifier	Maximum Output (kVA)	6.2		
	Rated Force	Sine (kN)		10	Dimensions (mm)	580 × 1950 × 850	
		Random (kN rms)		7	Mass (kg)	260	
		Shock (kN)	20	Controller See Vibration Controller K2			
	Maximum Acceleration	Sine (m/s ²)	400	Cooling	Cooling Method	Air cooling	
		Random (m/s ² rms)	280		Blower	Dimensions W × H × D (mm) ^{*3}	479 × 1075 × 667
		Shock (m/s ² peak)	800		Mass (kg)	56	
	Maximum Velocity	Sine (m/s)	1.2		Wattage (kw)	2.2	
		Shock (m/s peak)	2.0	Duct Hose Diameter (φ)	200		
	Maximum Displacement (mmp-p)	76.2	*1 Power supply required is 3-phase 200/220/380/400/415 V, 50/60 Hz. Voltage Down Transformer (Step-down transformer) is required for other voltage. *2 Breaker capacity for 200 V. *3 Specification above applies to 60 Hz. Dimensions change for 50 Hz. *The specification shows the maximum system performance. For long-duration tests, system must be de-rated up to 70%. Continuous use at maximum levels may cause failure. Please contact IMV if your system operates at more than 70%. *Frequency range values vary according to the sensor and vibration controller. *Armature mass and acceleration may change when a chamber is added.				
	Maximum Load (kg)	1000					
	Power Requirements (kVA) ^{*1}	11.9					
Breaker Capacity (A) ^{*2}	50						
Vibration Generator		Model					C10
Armature Mass (kg)	25	Allowable Eccentric Moment (N·m)	686				
Armature Diameter (φmm)	300	Dimensions (mm)	1100 × 1142 × 840				
Mass (kg)	2000						

K-series

High Excitation Force Water Cooled Range



K350
(With a slip table)

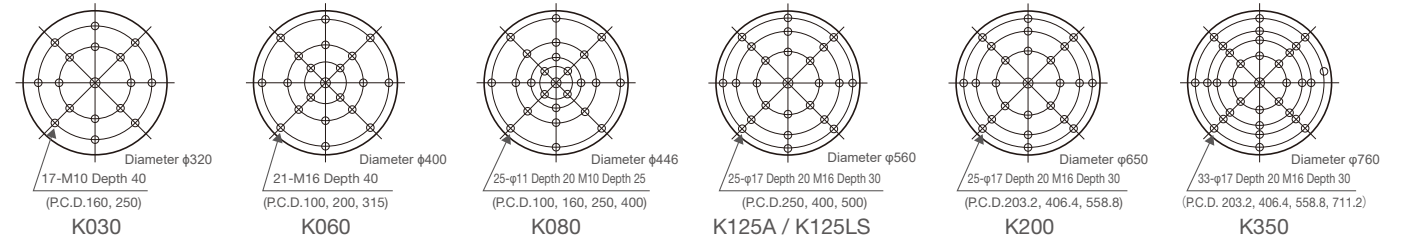
High excitation force and silent water cooled system for improving test environment

K-series, high excitation force water cooled vibration simulating test systems fully developed by IMV. Advanced function of the K-series will significantly improve the test environment.

[Silent system design] The water cooling system produces neither the intake nor exhaust sounds that an air cooling system emits.

[Record of significant accomplishments] IMV has been developing the most advanced water cooled system.

Table Insert Pattern (Unit: mm)



Specifications

System Model		K030/SA4HAG	K062/SA8HAG ⁴	K080/SA10HAG ⁴	K100A/SA14HAG ⁴	K125A/SA18HAG ⁴	K100LS/SA16HAG ⁴	K125LS/SA20HAG ⁴	K160/SA20HAG ⁴	K200/SA24HAG ⁴	K350/SA36HAG ⁴	
System Specifications	Frequency Range (Hz)	0-3000	0-2500	0-2500	0-2500	0-2500	0-2000	0-2000	0-2000	0-2000	0-2000	
	Rated Force	Sine (kN)	30.8	61.7	80	100	125	100	125	160	200	350
		Random (kN rms) ¹	21.5	61.7	80	100	125	100	125	160	200	315
		Shock (kN)	61.6	123.4	160	200	250	200	250	320	400	700
	Maximum Acc.	Sine (m/s ²)	1000	1000	1000	1000	1000	1000	1000	800	1000	1000
		Random (m/s ² rms)	557	700	700	700	700	700	700	560	700	700
		Shock (m/s ² peak)	2000	2000	2000	2000	2000	2000	2000	1600	2000	2000
	Maximum Vel.	Sine (m/s) ³	1.8	2.0	2.0	2.0	2.0	2.0	2.0	2.0	2.0	2.0
		Shock (m/s peak)	1.8	2.0	2.0	2.0	2.0	2.0	2.0	2.4	2.4	3.5
	Maximum Disp.	Sine (mmp-p)	51	51	51	51	51	100	100	76.2	76.2	76.2
		Maximum Travel (mmp-p)	58	60	59	62	62	116	116	86	86	94
	Maximum Load (kg)		500	1000	1000	2000	2000	2000	2000	2000	2000	3000
Power Requirements (kVA) ²		49	87	100	150	170	170	190	270	300	325	
Breaker Capacity (A) ⁴		175	350	350	600	600	600	700	-	-	-	
Vibration Generator	Model	K030	K060	K080	K125A	K125A	K125LS	K125LS	K200	K200	K350	
	Armature Mass (kg)	27	40	60	80	80	100	100	200	200	350	
	Armature Diameter (φmm)	320	400	446	560	560	560	560	650	650	760	
	Allowable Eccentric Moment (N·m)	980	980	1550	2450	2450	2450	2450	4900	4900	4900	
	Dimensions (mm) W×H×D	1100×1090×824	1380×1085×1000	1595×1200×1050	1776×1373×1300	1776×1373×1300	1990×1546×1370	1990×1546×1370	2465×1908×1740	2465×1908×1740	3020×2306×2080	
	Shaker Body Diameter (φmm)	760	900	1000	1100	1100	1100	1100	1260	1260	1630	
	Mass (kg)	3000	3700	5000	7000	7000	8000	8000	19000	19000	40000	
Power Amplifier	Model	SA4HAG-K30	SA8HAG-K60	SA10HAG-K80	SA14HAG-K125A	SA18HAG-K125A	SA16HAG-K125LS	SA20HAG-K125LS	SA20HAG-K200	SA24HAG-K200	SA36HAG-K350	
	Maximum Output (kVA)	33	60	100	98	124	124	155	256	320	400	
	Dimensions (mm) W×H×D	580×1950×850	1160×1950×850	1160×1950×850	1740×1950×850	1740×1950×850	1740×1950×850	1740×1950×850	2320×1950×850	2900×1950×850	4060×1950×850	
Mass (kg)	950	1350	1500	2500	2600	2600	2600	3300	4850	5450		
Controller	Vibration Controller	See Vibration Controller K2										
Cooling	Cooling Method	Shaker: Water cooling/Power Amplifier: Air Cooling										
	Primary Cooling Water (ℓ/min)	195	260	390	390	390	390	390	650 ⁵	650 ⁵	650 ⁵	
	Heat Exchanger	Dimensions (mm) W×H×D	580×1700×850	580×1700×850	580×1700×850	580×1700×850	580×1700×850	580×1700×850	580×1700×850	1050×1900×800	1050×1900×800	1200×1950×1400
Mass (kg)		400	400	400	400	400	400	400	600	600	950	

Eco Specifications

System Model		K030/EM4HAG	K062/EM8HAG ⁴	K080/EM10HAG ⁴	K100A/EM14HAG ⁴	K125A/EM18HAG ⁴	K100LS/EM16HAG ⁴	K125LS/EM20HAG ⁴	K160/EM20HAG ⁴	K200/EM24HAG ⁴	K350/EM36HAG ⁴	
System Specifications	Frequency Range (Hz)	0-3000	0-2500	0-2500	0-2500	0-2500	0-2000	0-2000	0-2000	0-2000	0-2000	
	Rated Force	Sine (kN)	30.8	61.7	80	100	125	100	125	160	200	350
		Random (kN rms) ¹	21.5	61.7	80	100	125	100	125	160	200	315
		Shock (kN)	61.6	123.4	160	200	250	200	250	320	400	700
	Maximum Acc.	Sine (m/s ²)	1000	1000	1000	1000	1000	1000	1000	800	1000	1000
		Random (m/s ² rms)	557	700	700	700	700	700	700	560	700	700
		Shock (m/s ² peak)	2000	2000	2000	2000	2000	2000	2000	1600	2000	2000
	Maximum Vel.	Sine (m/s) ³	1.8	2.0	2.0	2.0	2.0	2.0	2.0	2.0	2.0	2.0
		Shock (m/s peak)	1.8	2.0	2.0	2.0	2.0	2.0	2.0	2.4	2.4	3.5
	Maximum Disp.	Sine (mmp-p)	51	51	51	51	51	100	100	76.2	76.2	76.2
		Maximum Travel (mmp-p)	58	60	59	62	62	116	116	86	86	94
	Maximum Load (kg)		500	1000	1000	2000	2000	2000	2000	2000	2000	3000
Power Requirements (kVA) ²		49	87	100	150	170	170	190	270	300	325	
Breaker Capacity (A) ⁴		175	350	350	600	600	600	700	-	-	-	
Vibration Generator	Model	K030	K060	K080	K125A	K125A	K125LS	K125LS	K200	K200	K350	
	Armature Mass (kg)	27	40	60	80	80	100	100	200	200	350	
	Armature Diameter (φmm)	320	400	446	560	560	560	560	650	650	760	
	Allowable Eccentric Moment (N·m)	980	980	1550	2450	2450	2450	2450	4900	4900	4900	
	Dimensions (mm) W×H×D	1100×1090×824	1380×1085×1000	1595×1200×1050	1776×1373×1300	1776×1373×1300	1990×1546×1370	1990×1546×1370	2465×1908×1740	2465×1908×1740	3020×2306×2080	
	Shaker Body Diameter (φmm)	760	900	1000	1100	1100	1100	1100	1260	1260	1630	
	Mass (kg)	3000	3700	5000	7000	7000	8000	8000	19000	19000	40000	
Power Amplifier	Model	EM4HAG-K30	EM8HAG-K60	EM10HAG-K80	EM14HAG-K125A	EM18HAG-K125A	EM16HAG-K125LS	EM20HAG-K125LS	EM20HAG-K200	EM24HAG-K200	EM36HAG-K350	
	Maximum Output (kVA)	33	60	100	98	124	124	155	256	320	400	
	Dimensions (mm) W×H×D	1160×1950×850	1160×1950×850	1160×1950×850	1740×1950×850	1740×1950×850	1740×1950×850	1740×1950×850	2320×1950×850	2900×1950×850	4060×1950×850	
Mass (kg)	950	1350	1500	2500	2600	2600	2600	3300	4850	5450		
Controller	Vibration Controller	See Vibration Controller K2										
Cooling	Cooling Method	Shaker: Water cooling/Power Amplifier: Air Cooling										
	Primary Cooling Water (ℓ/min)	195	260	390	390 ⁵	390 ⁵	390 ⁵	390 ⁵	650 ⁵	650 ⁵	590 ⁵	
	Heat Exchanger	Dimensions (mm) W×H×D	580×1700×850	580×1700×850	580×1700×850	580×1700×850	580×1700×850	580×1700×850	580×1700×850	1050×1900×800	1050×1900×800	1200×1950×1400
Mass (kg)		400	400	400	400	400	400	400	600	600	950	

¹ Random force ratings are specified in accordance with ISO5344 conditions. Please contact IMV or your local distributor with specific test requirements. ² Power supply: 3-phase 200/220/240/380/400/415 V (K200 and K350 is AC380/400/415V), 50/60 Hz. A transformer is required for other supply voltages. ³ If the tests (Sweep or Spot) include high velocity, the maximum velocity value should be reduced to 1.4 m/s. ⁴ Breaker capacity for 200 V ⁵ Bypass circuit is needed. Please contact IMV or your local distributor for further information. ⁶ An export license is required for exporting the shaker system of over 50 kN sine force. (See P. 76) ^{*}The specification shows the maximum system performance. For long-duration tests, system must be de-rated up to 70%. Continuous use at maximum levels may cause failure. Please contact IMV if your system operates at more than 70%. ^{*}For random vibration tests, please set the test definition of the peak value of acceleration waveform to operate at less than the maximum acceleration of shock. ^{*}Frequency range values vary according to the sensor and vibration controller. ^{*}Armature mass and acceleration may change when a chamber is added. ^{*}Mass and dimensions may change for CE-marked systems.

m-series

Low Acoustic Noise and Compact Range



m030/MA1

Accessories

A pair of carrying handles

Safely and easily carried by one or two operators.

*Removable m030 and m060 only



Air pump

The vibration table height is adjusted to compensate for payload weight using an air pump.



Silent model suitable for abnormal noise inspection

Compact and silent design, but also powerful enough for full-scale tests.

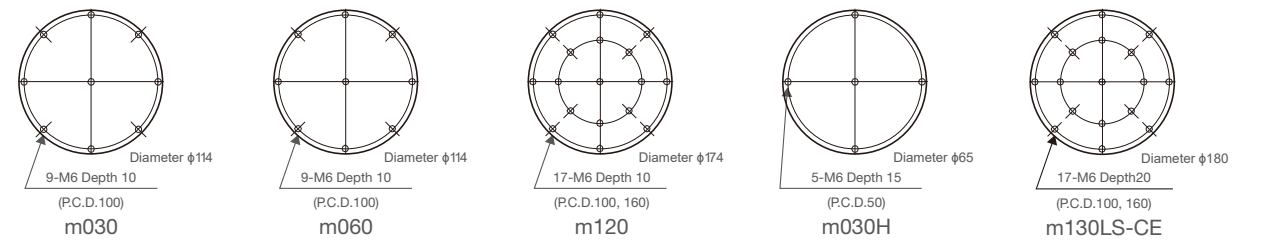
[Silent design employing a built-in cooling fan] DC-powered cooling fan is built into the shaker. Natural air-cooling is also used when the cooling fan is stopped for silent operation (with a reduction in performance).

Specifications

System Model		m030/MA1-CE	m060/MA1-CE	m120/MA1-CE	m030H/MA1	m130LS/MA1-CE	
System Specifications	Frequency Range (Hz)	0-3000	0-3000	0-2000	1000-10000	2 - 1000	
	Rated Force	Sine (N)	300	600	1200	380	1300
		Random (N rms)	210	420	840	266	650
		Shock (N)	300	600	1200	380	1300
	Maximum Acc.	No Load (m/s ²)	500	500	500	200	130
		0.5kg Load (m/s ²)	272	352	413	158	123
		1.0kg Load (m/s ²)	187	272	352	131	118
	Maximum Velocity (m/s)	1.6	1.6	1.6	— *1	1.0	
	Maximum Displacement (mmp-p)	26	30	30	— *1	51	
	Maximum Load (kg)	15	15	120	15	100	
Power Requirements (kVA)*2	0.4	0.7	1.1	0.5	1.0		
Vibration Generator	Model	m030-CE	m060-CE	m120-CE	m030H	m130LS-CE	
	Armature Support Method	Diaphragm spring	Diaphragm spring	Air suspension	Rubber spring	Air Suspension	
	Armature Mass (kg)	0.6	1.2	2.4	1.9	10	
	Armature Diameter (φmm)	114	114	174	65	180	
	Dimensions (mm)	φ190×H240	φ230×H281	φ320×H327*3	φ190×H275	W410 × H592 × D460	
	Mass (kg)	22	40	110	30	250	
Power Amplifier	Model	MA1-CE	MA1-CE	MA1-CE	MA1-CE	MA1-CE	
	Maximum Output (kVA)	1	1	1	1	1	
	Dimensions (mm) W×H×D	430×149×430	430×149×430	430×149×430	430×149×430	430×149×430	
	Mass (kg)	25	25	25	25	25	
Cooling	Cooling Method	Air cooling					
	Blower	Housed in vibration generator					

*1 The displacement at the lower limit of frequency (1000 Hz) and maximum acceleration (200 m/s²) is so small that there is no certified value.
 *2 Power supply: single-phase AC100 V/200 V or AC110 V/220 V or AC120 V/240 V ±10% 50/60 Hz. A transformer is required for other supply voltages.
 *3 Insulation pad (W410 x H45 x D410 mm) is standard equipment.
 *The specification shows the maximum system performance. For long-duration tests, system must be de-rated up to 70%. Continuous use at maximum levels may cause failure. Please contact IMV if your system operates at more than 70%.
 *Frequency range values vary according to the sensor and vibration controller.

Table Insert Pattern (Unit: mm)



Option

Head expander

Model	Dimensions (mm)	Mass (kg)	Maximum frequency (Hz)	m030	m060	m120
TBV-125-□-A	125×125×t 20	0.9	2000	○	○	—
TBV-200-□-A	200×200×t 20	2.5	1500	○*	○	○
TBV-315-□-A	315×315×t 30	8.5	1000	—	○*	○
TBV-400-□-A	400×400×t 35	14.4	600	—	—	○

*"A" at the end of model number shows that material is aluminum alloy. Add the vibration generator type where "□" is shown.

*A supplementary guidance system using linear bearings is used with the vibration generator when combined with the head expander. Armature mass is increased due to the addition of the guide support.



Supplementary guidance system (GDP)

Slip table

Model	Dimensions (mm)	Maximum frequency (Hz)	Mass (kg)			
			m030	m060	m120	m130LS
TBH-200	200×200	500	4	4	5.5	—
TBH-315	315×315	500	7.5	7.5	9	—
TBH-400	400×400	500	—	12.3	14	—
TBH-500	500×500	500	—	—	—	28

*The material of slip plate is aluminum alloy.

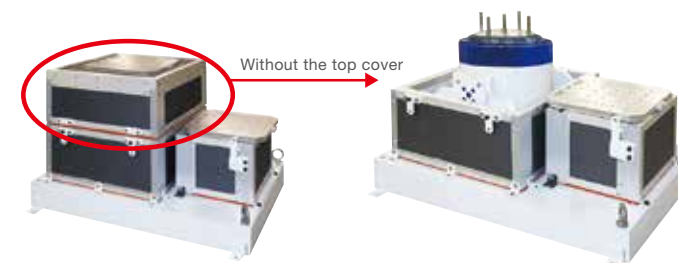


Head expander



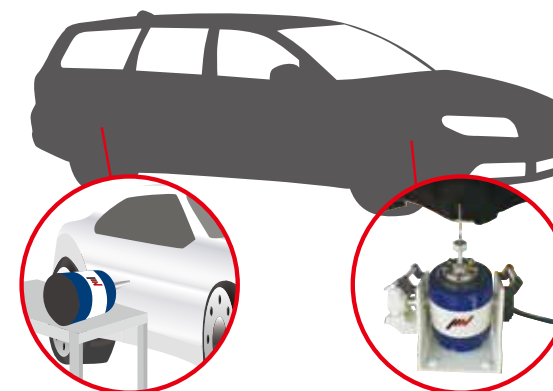
Slip table

Soundproof enclosure



Acoustic noise testing is made possible by placing the shaker in a soundproof box.

Excitation at any selected point



Excitation at body

Excitation at drive shaft

Modal analysis can be done by applying vibration to the car body, etc.

Emergency stop switch



It is possible to stop the system in an emergency.

Moving device



Eliminates the hassle of moving the machine and enables tests to be performed in any available space.

VSH/PET

High Frequency and Compact Range

Suitable for bench-top simulation

Ideal for bench-top testing

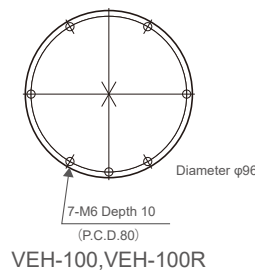
[Compact] Portable

[Compatible vibration controllers] Versatile vibration controller provides wide range of test types.



VEH-100

Table Insert Pattern (Unit:mm)



Specifications

System Model		VSH-100-M2	VSH-100R-M2	
System Specifications	Frequency Range (Hz)	0-8000	0-10000	
	Rated Force	Sine (N)	980	980
		Random (N rms)	392	392
		Shock (N)	980	980
	Maximum Acceleration (m/s ²)*1	980	980	
	Maximum Velocity (m/s)	0.8	0.8	
	Maximum Displacement (mmp-p)	10	10	
	Maximum Load (kg)	30	Up to the spring constant	
Power Requirements (kVA)*2	4.0	4.0		
Vibration Generator	Model		VEH-100	VEH-100R
	Armature Support Method	Roller / Air suspension	Flexures / Rollers	
	Armature Support Spring Constant (kN/m)	—	49	
	Armature Mass (kg)	1.0	1.0	
	Armature Diameter (φmm)	96	96	
	Dimensions (mm) W×H×D	φ390×H306	φ390×H306	
	Mass (kg)	120	120	
Power Amplifier	Model		VAH-M2	VAH-M2
	Maximum Output (kVA)	1.5	1.5	
	Dimensions (mm) W×H×D	580×1750×850	580×1750×850	
	Mass (kg)	230	230	
Cooling	Cooling Method		Air cooling	Air cooling
	Blower	Dimensions W×H×D (mm)	247×252×284	247×252×284
		Mass (kg)	10.5	10.5

*1 Spec described above is under bare table condition. The maximum acceleration decreases when accelerometer and mounting adapter are mounted.

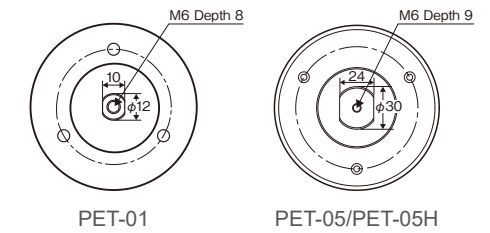
*2 Power supply : three-phase AC200 V±10 %, 50 / 60 Hz (Voltage down transformer [step-down transformer] is required for other voltage)

* The specification shows the maximum system performance. For long-duration tests, de-rating by up to 70 % must be applied. Continuous use at maximum levels may cause failure. Please contact IMV if you use more than 70 %.

* Frequency range values vary according to sensor and vibration controller.

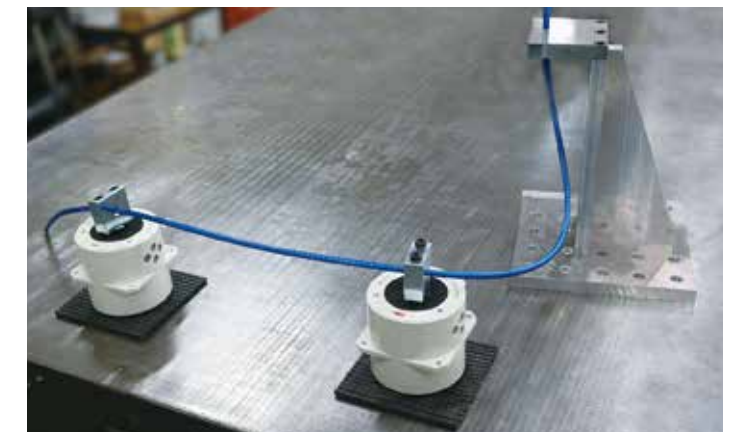


Table Insert Pattern (Unit:mm)



Option

Adapter for PET



By attaching the adapter to PET series, it is possible to increase the moment restraint force and it can be used as a vibration source for modal analysis. It also possible to apply vibration to products intricately shaped by combining multiple units.

Specifications

System Model		PET-01/PA	PET-05/PA	PET-05H/PA	
System Specifications	Frequency Range (Hz)	2-12000	2-14000	5-40000	
	Rated Force	Sine (N)	9.8	49	49
		Random (N rms)	—	—	—
		Shock (N)	—	—	—
	Maximum Acceleration (m/s ²)*1	326	326	376	
	Maximum Velocity (m/s)	—	—	—	
	Maximum Displacement (mmp-p)	5	5	5	
	Maximum Load (kg)	Up to the spring constant	Up to the spring constant	Up to the spring constant	
Power Requirements (kVA)*2	0.08	0.1	0.1		
Vibration Generator	Model		PET-01	PET-05	PET-05H
	Armature Support Method	Diaphragm spring	Diaphragm spring	Diaphragm spring	
	Armature Support Spring Constant (kN/m)	9.8	15.6	15.6	
	Armature Mass (kg)	0.03	0.15	0.13	
	Armature Diameter (φmm)	12	30	30	
	Dimensions (mm) W×H×D	75×72×75	116×115×116	116×115×116	
	Mass (kg)	1.3	5.0	5.0	
Power Amplifier	Model		PA01	PA05	PA05H
	Maximum Output (kVA)	0.03	0.045	0.045	
	Dimensions (mm) W×H×D	279 × 140 × 280	279 × 140 × 280	279 × 140 × 280	
	Mass (kg)	9	9	9	
Cooling	Cooling Method	Natural radiation	Natural radiation	Natural radiation	

*1) Spec described above is under bare table condition. The maximum acceleration decreases when accelerometer and mounting adapter are mounted.

*2) Power supply : single phase AC100 V ±10 %, 50/60 Hz (Voltage down transformer [step-down transformer] is required for other voltage)

* The specification shows the maximum system performance. For long-duration tests, system must be de-rated up to 70%. Continuous use at maximum levels may cause failure. Please contact IMV if your system operates at more than 70%.

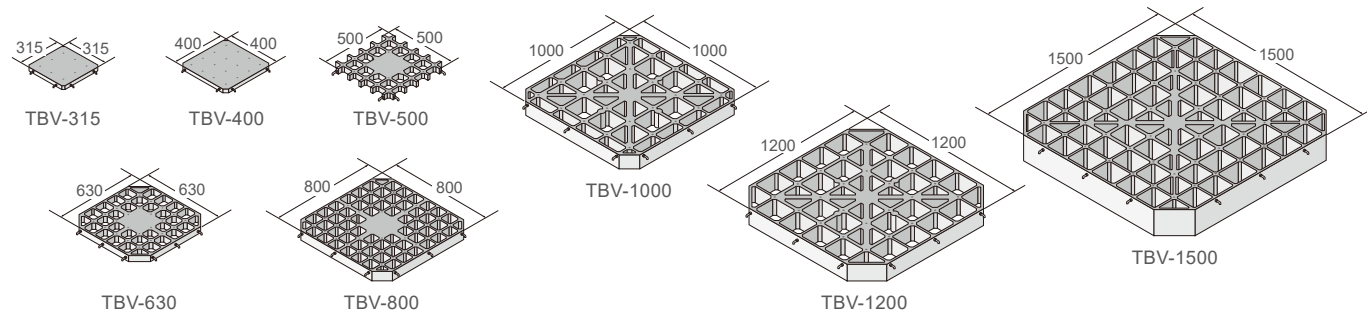
* Frequency range values vary according to the sensor and vibration controller.

Optional Units

Head expanders and cubic fixtures

Head expanders

Where the size of the specimen exceeds the dimensions of the armature a head expander should be used. Generally, the maximum usable frequency is reduced as the size of specimen increases. The head expander should be selected based on specimen size and maximum test frequency required. Properties of the standard range of head expanders is shown in the table.

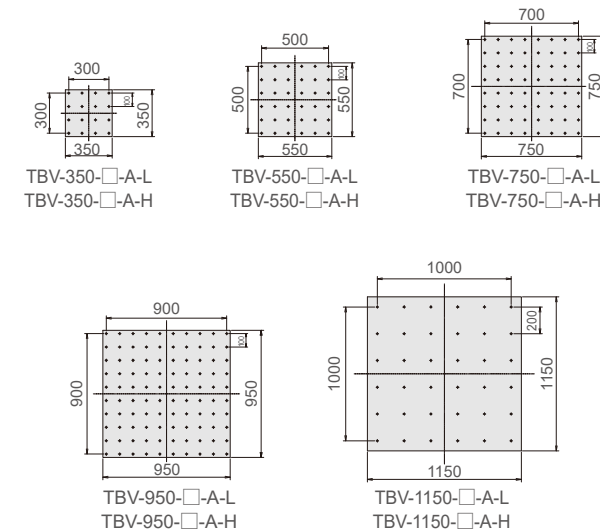


Model	Dimensions (mm)	Mass (kg)	Maximum Frequency (Hz)	A-series							i-series	
				A11	A22	A30	A45	A65	A74	i210	i220	
TBV-125-□-A	125×125	0.9	2000	—	—	—	—	—	—	—	○	—
TBV-125-□-M	t 20	0.6		—	—	—	—	—	—	—	—	○
TBV-315-□-A	315×315	8.5	1000	○	○	○	—	—	—	—	○	○
TBV-315-□-M	t 30	5.8		○	○	○	—	—	—	—	—	○
TBV-400-□-A	400×400	13	600	○	○	○	—	—	—	—	○	○
TBV-400-□-M	t 30	9		○	○	○	—	—	—	—	—	○
TBV-500-□-A	500×500	15	500	○	○	○	○	○	○	○	○	○
TBV-500-□-M	t 40	10.4		○	○	○	○	○	○	○	○	○
TBV-630-□-A	630×630	19	360	○	○	○	○	○	○	○	○	○
TBV-630-□-M	t 45	12.5		○	○	○	○	○	○	○	○	○
TBV-800-□-A	800×800	45	350	○	○	○	○	○	○	○	—	○
TBV-800-□-M	t 70	30		○	○	○	○	○	○	○	○	—
TBV-1000-□-A	1000×1000	110	350	○	○	○	○	○	○	○	—	—
TBV-1000-□-M	t 110	78		○	○	○	○	○	○	○	○	—
TBV-1200-□-A	1200×1200 t 125	180	200	—	○	○	○	○	○	○	—	—
TBV-1500-□-A	1500×1500 t 200	300		—	—	—	—	—	—	—	—	—

Model	Dimensions (mm)	Mass (kg)	Maximum Frequency (Hz)	J-series				C-series		K-series						
				J230	J240	J250	J260	C10	K030	K060	K080	K125	K125LS	K200	K350	
TBV-125-□-A	125×125	0.9	2000	—	—	—	—	—	—	—	—	—	—	—	—	—
TBV-125-□-M	t 20	0.6		—	—	—	—	—	—	—	—	—	—	—	—	—
TBV-315-□-A	315×315	8.5	1000	○	○	—	—	○	—	—	—	—	—	—	—	—
TBV-315-□-M	t 30	5.8		○	○	—	—	○	—	—	—	—	—	—	—	—
TBV-400-□-A	400×400	13	600	○	○	—	—	○	—	—	—	—	—	—	—	—
TBV-400-□-M	t 30	9		○	○	—	—	○	—	—	—	—	—	—	—	—
TBV-500-□-A	500×500	15	500	○	○	○	○	○	○	○	○	—	—	—	—	—
TBV-500-□-M	t 40	10.4		○	○	○	○	○	○	○	○	○	—	—	—	—
TBV-630-□-A	630×630	19	360	○	○	○	○	○	○	○	○	○	—	—	—	—
TBV-630-□-M	t 45	12.5		○	○	○	○	○	○	○	○	○	○	—	—	—
TBV-800-□-A	800×800	45	350	○	○	○	○	○	○	○	○	○	○	○	○	○
TBV-800-□-M	t 70	30		○	○	○	○	○	○	○	○	○	○	○	○	○
TBV-1000-□-A	1000×1000	110	350	○	○	○	○	○	○	○	○	○	○	○	○	○
TBV-1000-□-M	t 110	78		○	○	○	○	○	○	○	○	○	○	○	○	○
TBV-1200-□-A	1200×1200 t 125	180	200	—	○	○	○	○	○	○	○	○	○	○	○	○
TBV-1500-□-A	1500×1500 t 200	300		—	—	—	○	○	○	○	○	○	○	○	○	○

Model names ending with "A" indicate aluminum body and "M" indicate magnesium alloy. Add the vibration generator type where "□" is shown. *The data shown refers to the IMV standard range. Custom designs can also be supplied.

Head expander (flat surface type)



Model	Dimensions (mm)	Mass (kg)	Maximum Frequency (Hz)	Specimen Mounting Screw	Screw Pitch
TBV-350-□-A-L	350×350×t 33	6	750	M10 Depth 25	□100 mm Pitch
TBV-350-□-A-H	350×350×t 65	11	1500	M10 Depth 25	□100 mm Pitch
TBV-550-□-A-L	550×550×t 30	17	300	M10 Depth 25	□100 mm Pitch
TBV-550-□-A-H	550×550×t 60	30	600	M10 Depth 25	□100 mm Pitch
TBV-750-□-A-L	750×750×t 38	30	200	M10 Depth 25	□100 mm Pitch
TBV-750-□-A-H	750×750×t 75	55	400	M10 Depth 25	□100 mm Pitch
TBV-950-□-A-L	950×950×t 45	45	150	M10 Depth 25	□100 mm Pitch
TBV-950-□-A-H	950×950×t 90	80	300	M10 Depth 25	□100 mm Pitch
TBV-1150-□-A-L	1150×1150×t 60	90	120	M10 Depth 25	□200 mm Pitch
TBV-1150-□-A-H	1150×1150×t 120	160	240	M10 Depth 25	□200 mm Pitch

Model names ending with "A" indicate aluminum body. Add the vibration generator type where "□" is shown. Please contact us for more information.

Options for use with vertical tables

Guide system, additional air spring

The following option increases the allowable overturning moment of the head expander.

- Additional guide system
Enabling larger or off-centre specimens to be tested.
- Additional air spring
Providing additional load support to accommodate higher specimen & fixture mass.

*Some models do not support the options above



High-frequency model

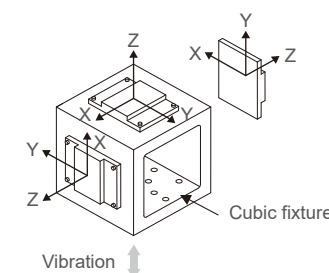
A head-expander having exceptionally low mass and special dual conical shape giving excellent damping.



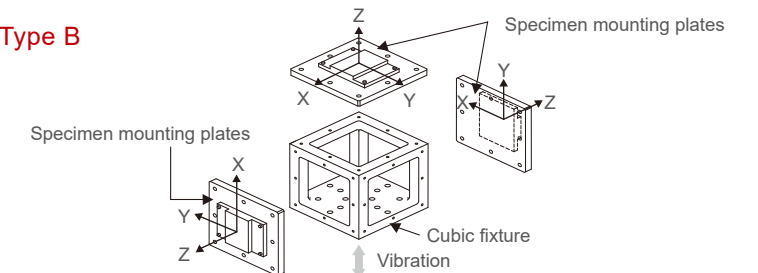
Cubic fixture

The specimen can be fastened to the top or the side face of the cubic fixture where testing in each axis is required. Two types of cubic fixture are available. Type A has fixing holes on each face, Type B has specimen mounting plates which attach to the cubic frame.

Type A



Type B



Cubic Fixture (Type A)			
Model	Dimensions (mm)	Mass (kg)	Maximum Frequency (Hz)
TCJ-A150-□-A	150×150×150	5.5	2000
TCJ-A150-□-M		4	
TCJ-A160-□-A	160×160×160	6.5	2000
TCJ-A160-□-M		4.6	
TCJ-A200-□-A	200×200×200	8	1000
TCJ-A200-□-M		5.6	
TCJ-A250-□-A	250×250×250	13.5	650
TCJ-A250-□-M		9.5	
TCJ-A300-□-A	300×300×300	20	400
TCJ-A300-□-M		14	

Cubic Fixture (Type B)				Specimen Mounting Plates	
Model	Dimensions (mm)	Mass (kg)	Maximum Frequency (Hz)	Model	Mass (kg)
TCJ-B150-□-A	150×150×150	3.5	2000	TCJ-B150-P-A	1.5
TCJ-B150-□-M		2.5		TCJ-B150-P-M	1.1
TCJ-B160-□-A	160×160×160	4	2000	TCJ-B160-P-A	1.7
TCJ-B160-□-M		2.8		TCJ-B160-P-M	1.3
TCJ-B200-□-A	200×200×200	10	2000	TCJ-B200-P-A	3.5
TCJ-B200-□-M		7		TCJ-B200-P-M	2.5
TCJ-B250-□-A	250×250×250	20	1000	TCJ-B250-P-A	4.5
TCJ-B250-□-M		14		TCJ-B250-P-M	3.2
TCJ-B300-□-A	300×300×300	20	600	TCJ-B300-P-A	6.5
TCJ-B300-□-M		14		TCJ-B300-P-M	4.5

Model names ending with "A" indicate aluminum body and "M" indicate magnesium alloy. Add the vibration generator type where "□" is shown.

Optional Units

Slip table

Slip table

A slip table is required for testing a specimen along its horizontal axis, or when a heavy specimen is to be tested. Slip tables are designed to achieve low friction in the driven axis, while supporting heavy loads and introducing minimal waveform distortion.



Type and features of slip table

MS: Simultaneous use of Mechanical Bearing and Oil Film

Employs a combined structure of a high rigid linear bearing and an oil film method which purpose is to improve vibration dumping characteristic.

Model	TBH-550-□-A-MS			TBH-750-□-A-MS			TBH-950-□-A-MS			TBH-1150-□-A-MS		
Table Size (mm)	550 × 550			750 × 750			950 × 950			1150 × 1150		
Moment (N·m)	1100			2200			2200			4600		
Maximum Load (kg)	700			1000			1500			2000		
Vibration Generator	Moving Mass* (kg)	Frequency (Hz)	Table Thickness (mm)	Moving Mass* (kg)	Frequency (Hz)	Table Thickness (mm)	Moving Mass* (kg)	Frequency (Hz)	Table Thickness (mm)	Moving Mass* (kg)	Frequency (Hz)	Table Thickness (mm)
A11	55	2000	40	93	2000	40	138	1250	40	-	-	-
A22	58			95			140			198	800	40

Model	TBH-550-□-A-MS			TBH-750-□-A-MS			TBH-950-□-A-MS			TBH-1150-□-A-MS		
Table Size (mm)	550 × 550			750 × 750			950 × 950			1150 × 1150		
Moment (N·m)	1100			2200			2200			4600		
Maximum Load (kg)	700			1000			1500			2000		
Vibration Generator	Moving Mass* (kg)	Frequency (Hz)	Table Thickness (mm)	Moving Mass* (kg)	Frequency (Hz)	Table Thickness (mm)	Moving Mass* (kg)	Frequency (Hz)	Table Thickness (mm)	Moving Mass* (kg)	Frequency (Hz)	Table Thickness (mm)
A30	60	2000	40	100	2000	40	145	1250	40	203	800	40
A45	68			108			153			210		
A65				108			153			210		

*The weight is referring the plate made of aluminum.
 *□ is the model number of the vibration generator.

MB: Mechanical Bearing

Mechanical bearing employs the linear motion guide which incorporates a component with a linear rolling motion into practical use. It significantly contributes to high performance of table which are high-rigidity, high load and long stroke motion. Another strong feature of the mechanical bearing is easy to operate. Since it is light weighted and no need for a hydraulic unit.

Model	TBH-550-□-A-MB		
Table Size (mm)	550 × 550		
Moment (N·m)	9300		
Maximum Load (kg)	1000		
Vibration Generator	Moving Mass* (kg)	Frequency (Hz)	Table Thickness (mm)
A11	46	2000	30
A22	47		

Model	TBH-550-□-A-MB			TBH-750-□-A-MB			TBH-950-□-A-MB			TBH-1150-□-A-MB		
Table Size (mm)	550 × 550			750 × 750			950 × 950			1150 × 1150		
Moment (N·m)	9300			12700			19700			51500		
Maximum Load (kg)	1000			2000			2000			2000		
Vibration Generator	Moving Mass* (kg)	Frequency (Hz)	Table Thickness (mm)	Moving Mass* (kg)	Frequency (Hz)	Table Thickness (mm)	Moving Mass* (kg)	Frequency (Hz)	Table Thickness (mm)	Moving Mass* (kg)	Frequency (Hz)	Table Thickness (mm)
A30	47	2000	30	75	2000	30	106	2000	30	151	2000	40
A45	54			87			114			160		
A65				87			114			160		

*1 Above 1600 Hz, the force rolls-off at a rate of -6db/oct.
 *The weight is referring the plate made of aluminum.
 *□ is the model number of the vibration generator.
 *Please contact us about the table size over 1150 × 1300.

ST: Oil Film Type

It is supported on oil film. Constantly create oil film at reverse side of the table letting the table slide with low friction. Pump oil unit is located in the slip table base. Since moving mass is small, it becomes one of the most standard slip table with substantial sales record.

Model	TBH-500-□-A-ST			TBH-630-□-A-ST			TBH-800-□-A-ST			TBH-1000-□-A-ST		
Table Size (mm)	500 × 500			630 × 630			800 × 800			1000 × 1000		
Pitch Moment (N·m)	200			400			800			1300		
Maximum Load (kg)	200			300			400			500		
Vibration Generator	Moving Mass* (kg)	Frequency (Hz)	Thickness (mm)	Moving Mass* (kg)	Frequency (Hz)	Thickness (mm)	Moving Mass* (kg)	Frequency (Hz)	Thickness (mm)	Moving Mass* (kg)	Frequency (Hz)	Thickness (mm)
i210	33	2500	30	45	2000	30	-	-	-	-	-	-
i220							-	-	-	-	-	-
K030							65	30	100	1250	30	
K060	60	2000	50	80	50	115	2000	50	170	1250	50	
K080												-

*The material of slip plate is aluminum alloy. It is possible to change to magnesium. Please contact us for more information.
 *□ is the model number of the vibration generator.

TT-L: Hydrostatic Bearing (Low Pressure)/TT-H: Hydrostatic Bearing (High Pressure)

Locating multiple hydrostatic bearing on high rigid base to support slip table. Special purpose designed hydrostatic bearing realizes high load and allowable eccentric moment.

TT-L: Hydrostatic Bearing (Low Pressure)

Model	TBH-500-□-A-TTL			TBH-630-□-A-TTL			TBH-800-□-A-TTL			TBH-1000-□-A-TTL			TBH-1200-□-A-TTL			TBH-1500-□-A-TTL			TBH-1800-□-A-TTL			TBH-2000-□-A-TTL		
Table Size (mm)	500 × 500			630 × 630			800 × 800			1000 × 1000			1200 × 1200			1500 × 1500			1800 × 1800			2000 × 2000		
Pitch Moment (N·m)	1100			1100			2200			2200			4600			6500			10000			10000		
Maximum Load (kg)	700			1000			1000			1500			2000			2000			2500			2500		
Vibration Generator	Moving Mass* (kg)	Frequency (Hz)	Thickness (mm)	Moving Mass* (kg)	Frequency (Hz)	Thickness (mm)	Moving Mass* (kg)	Frequency (Hz)	Thickness (mm)	Moving Mass* (kg)	Frequency (Hz)	Thickness (mm)	Moving Mass* (kg)	Frequency (Hz)	Thickness (mm)	Moving Mass* (kg)	Frequency (Hz)	Thickness (mm)	Moving Mass* (kg)	Frequency (Hz)	Thickness (mm)	Moving Mass* (kg)	Frequency (Hz)	Thickness (mm)
i210	40	2000	30	53	2000	30	75	1600	30	105	1000	30	280	900	50	450	800	50	650	600	50	800	500	50
i220	43			55			78			108														
J230	50	1600	40	63	1600	40	85	1250	40	118	155	40	280	900	50	450	800	50	650	600	50	800	500	50
J240																								
J250																								
J260	70			85			115			155														

*The material of slip plate is aluminum alloy. It is possible to change to magnesium. Please contact us for more information. *□ is the model number of the vibration generator.

Model	TBH-550-□-A-TTL			TBH-750-□-A-TTL			TBH-950-□-A-TTL			
Table Size (mm)	550 × 550			750 × 750			950 × 950			
Pitch Moment (N·m)	1100			2200			2200			
Maximum Load (kg)	1000			1500			1500			
Vibration Generator	Moving Mass* (kg)	Frequency (Hz)	Thickness (mm)	Moving Mass* (kg)	Frequency (Hz)	Thickness (mm)	Moving Mass* (kg)	Frequency (Hz)	Thickness (mm)	
A11	52	2000	30	-	1600	30	-	1000	30	
A22	53			-			-			-
A30	53			78			105			
A45	64			89			115			
A65				89			115			

*Above 1600 Hz, the force rolls-off at a rate of -6db/oct.
 *□ is the model number of the vibration generator.

TT-H: Hydrostatic Bearing (High Pressure)

Model	TBH-500-□-A-TTH			TBH-630-□-A-TTH			TBH-800-□-A-TTH			TBH-1000-□-A-TTH			TBH-1200-□-A-TTH			TBH-1500-□-A-TTH			TBH-1800-□-A-TTH			TBH-2000-□-A-TTH		
Table Size (mm)	500 × 500			630 × 630			800 × 800			1000 × 1000			1200 × 1200			1500 × 1500			1800 × 1800			2000 × 2000		
Pitch Moment (N·m)	4000			4000			7700			7700			16000			22000			48000			48000		
Maximum Load (kg)	800			1200			1600			2000			2000			2000			3000			3000		
Vibration Generator	Moving Mass* (kg)	Frequency (Hz)	Thickness (mm)	Moving Mass* (kg)	Frequency (Hz)	Thickness (mm)	Moving Mass* (kg)	Frequency (Hz)	Thickness (mm)	Moving Mass* (kg)	Frequency (Hz)	Thickness (mm)	Moving Mass* (kg)	Frequency (Hz)	Thickness (mm)	Moving Mass* (kg)	Frequency (Hz)	Thickness (mm)	Moving Mass* (kg)	Frequency (Hz)	Thickness (mm)	Moving Mass* (kg)	Frequency (Hz)	Thickness (mm)
i210	60	2000	50	70	2000	50	115	2000	50	165	1250	50	280	900	50	450	800	50	650	600	50	800	500	50
i220	63			83			118			168														
J230	68			88			125			175														
J240	70			90			130			178														
J250	83			100			143			188														
J260	83			100			143			188														
K030	68			88			123			173														
K060	93			108			145			193														
K080	78			95			133			180														
K125	103			118			155			205														
K125LS	113	128	170	220																				

*The material of slip plate is aluminum alloy. It is possible to change to magnesium. Please contact us for more information. *□ is the model number of the vibration generator.

Model	TBH-550-□-A-TTH			TBH-750-□-A-TTH			TBH-950-□-A-TTH			
Table Size (mm)	550 × 550			750 × 750			950 × 950			
Pitch Moment (N·m)	4000			7700			7700			
Maximum Load (kg)	1200			2000			2000			
Vibration Generator	Moving Mass* (kg)	Frequency (Hz)	Thickness (mm)	Moving Mass* (kg)	Frequency (Hz)	Thickness (mm)	Moving Mass* (kg)	Frequency (Hz)	Thickness (mm)	
A11	52	2000	30	-	1600	30	-	1000	30	
A22	53			-			-			-
A30	53			78			105			
A45	66			89			115			
A65				89			115			

*Above 1600 Hz, the force rolls-off at a rate of -6db/oct.
 *□ is the model number of the vibration generator.

Optional Units

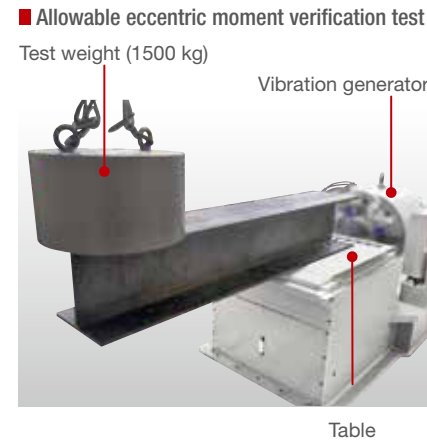
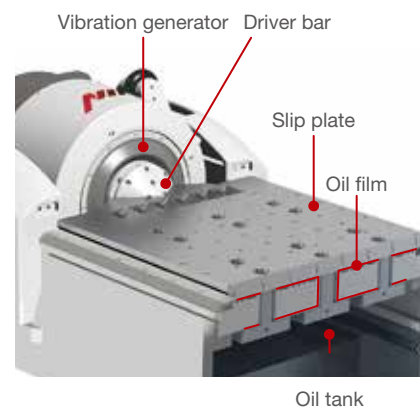
Slip table

(5) TH: Hydrostatic Bearing & Oil Film (A-series Only)

Slip table for A-series provides the following features with a newly developed hydrostatic and hydraulic bearing and new structure.

[Features]

- High moment resistance
- Low cross-axis acceleration
- Low distortion
- No requirement for a separate hydraulic unit
- Good work efficacy
- Smaller system installation space



Model	TBH-550TH		TBH-750TH		TBH-950TH		TBH-1150TH		TBH-1450TH	
Table Size (mm)	550 × 550		750 × 750		950 × 950		1150 × 1150		1450 × 1450	
Thickness (mm)	50		50		50		50		50	
Pitch Moment (N·m)	6000		66000		85000		85000		198000	
Maximum Load (kg)	1500		9000		9000		9000		9000	
Vibration Generator	Moving Mass* (kg)	Frequency (Hz)	Moving Mass* (kg)	Frequency (Hz)	Moving Mass* (kg)	Frequency (Hz)	Moving Mass* (kg)	Frequency (Hz)	Moving Mass* (kg)	Frequency (Hz)
A11	85	2000	159	2000	215	1250	298	800	452	500
A22										
A30										
A45	—	—	180	—	236	—	318	—	473	—
A65										
A74										

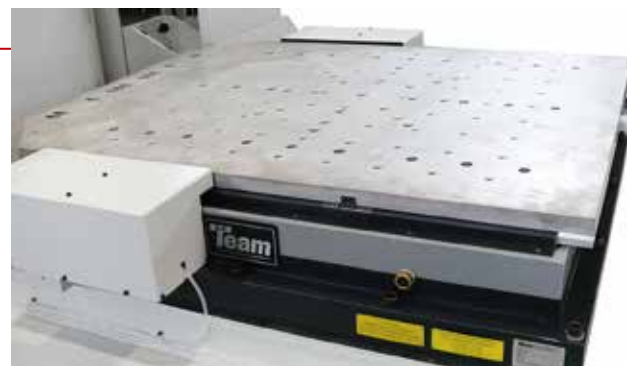
*The weight is referring the plate made of aluminum.

(6) T-Film bearing range

The T-Film bearing from Team Corporation is probably the most advanced design of linear bearing available to the vibration-test industry.

The slip table employs a number of bearings, each consisting of a U.S. patented bearing element and hydro-static oil film.

T-Film bearings provide excellent vibration waveform linearity and are considered to be the best solution for the aerospace industry and research establishments.

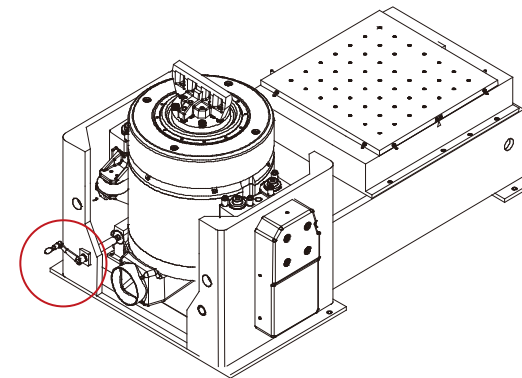


Option for slip table

1. Rotation reduction gearing

A reduction gearing unit enabling easier reconfiguration of the vibration generator.

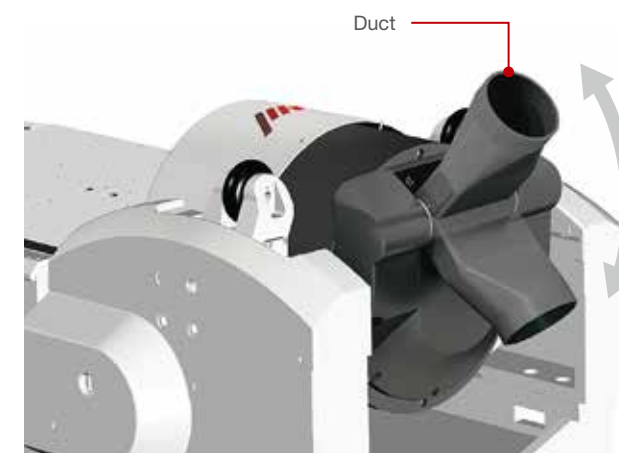
*i210 doesn't have this option.



3. Duct

A newly developed duct is provided as standard.

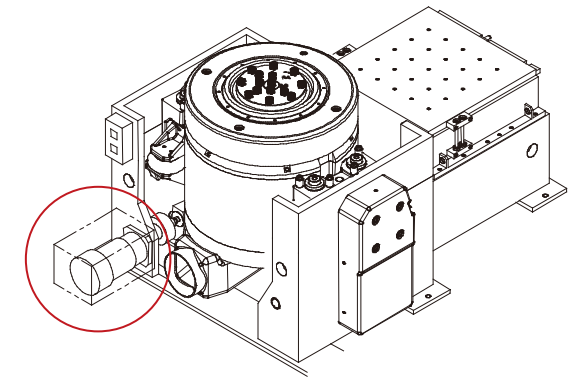
No operation needed for direction change between vertical and horizontal. Space behind the shaker is minimised.



2. Motor drive rotation

Powered rotation of the vibration generator.

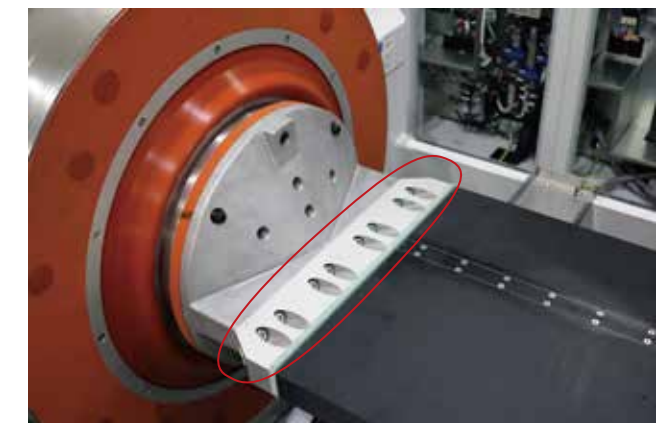
The motor-driven rotation can be optionally installed on systems equipped with reduction gearing.



4. Drive bar adapter with diagonal bolt access

Method of fastening drive bar to a slip table was simplified by reflecting customers feedback.

Usability is improved and easier torque management of bolts is realized. * Standard for MB/MS

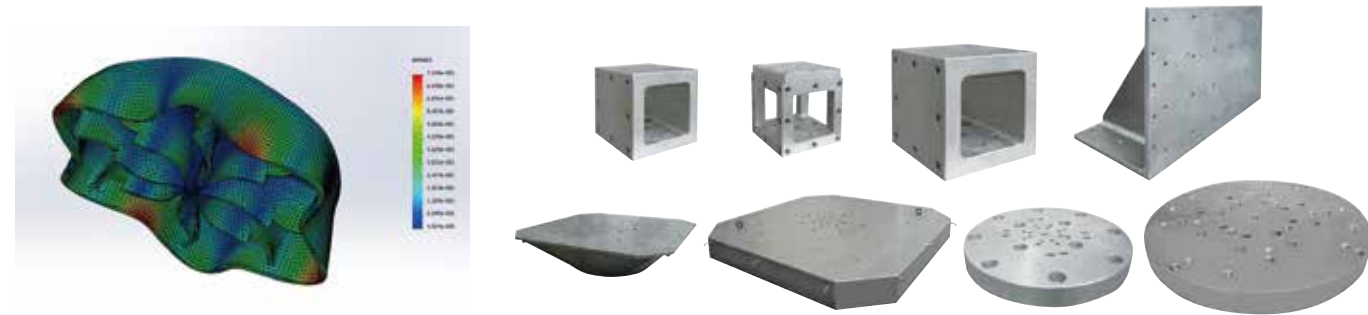


Optional Units

Fixture, Vibration Isolation, Reinforcement

Fixture

IMV has a range of fixtures, such as cube and 'L'-shaped types, to suit most applications. Customised fixtures are supplied, designed and analysed using finite-element modeling to ensure best performance.

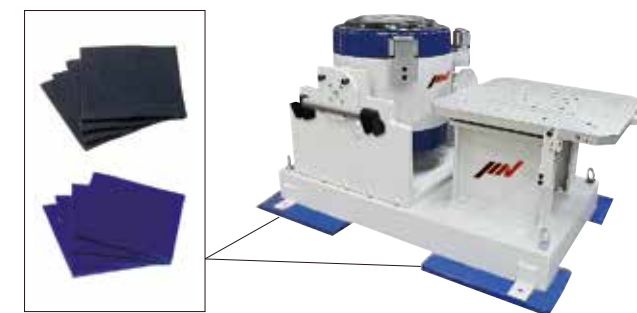


Vibration Isolation

Additional isolation mounts are available to reduce the effects of vibration on the floor and adjacent equipment.

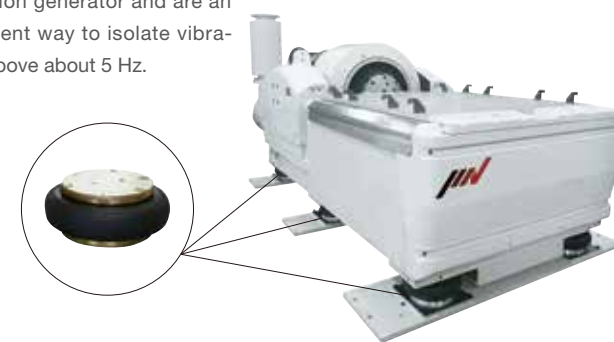
■ Insulation pad

These are simple to install by placing under the vibration generator.



■ Air spring

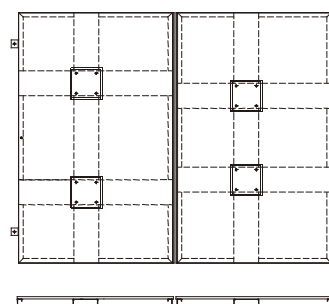
Air springs placed under each corner of the frame support the vibration generator and are an excellent way to isolate vibration above about 5 Hz.



Reinforcement

■ Load spreader base

The weight of the vibration generator can be distributed over a larger area where such load is acceptable.



Optional Units

Sound-proof enclosure, Cooling ducting, Launcher, System monitor

Sound-proof enclosure

A sound-proof enclosure for the cooling blower reduces noise in installations where the blower cannot be located outside the work area.



inside

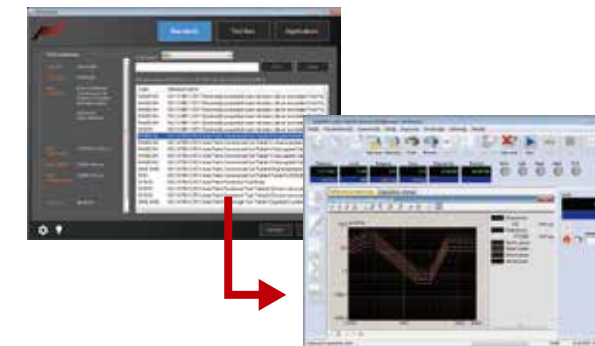
Cooling ducting

The standard arrangement for air-cooled systems is to install the blower inside the work area. Ducting the input air from outside eliminates the changes in ambient pressure and temperature caused by the cooling air flow.



Launcher

Test file will be automatically generated just on selection of the test condition defined by the test standard. Then, the test can be carried out just by pressing the start button.



In-built "Quick Help" provides guidance on each operation.

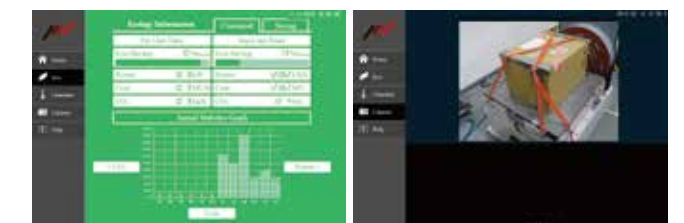
System monitor

Condition of "vibration generator, amplifier test proceeding, specimen status" can be observed on the PC or tablet by either wired or wireless LAN. Solution will be seen on the Web browser on occurrence of any error. Installation of additional software is not necessary to the PC nor tablet.



Home screen

Home screen (error)



Eco screen

Camera screen

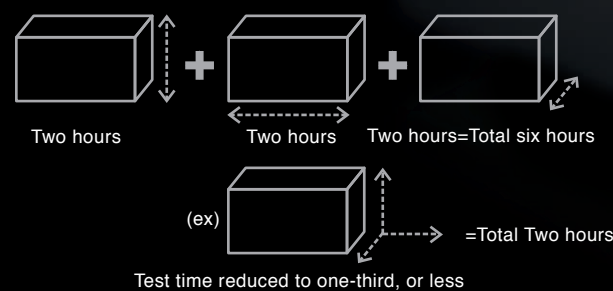
Vibration Test Systems

Multi-axis systems

- 2-Axis Changeover Systems **DC-series** >> P.35
- 3-Axis Changeover Systems **TC-series** >> P.36
- 2-Axis Simultaneous Systems **DS-series** >> P.37
- 3-Axis Simultaneous Systems **TS-series** >> P.38
- 6 Degrees of Freedom Systems **TTS-series** >> P.39

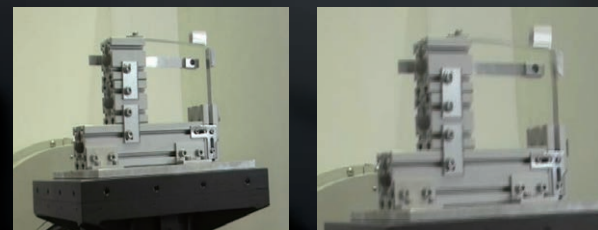
Reduced test time

Testing in three-axis simultaneously instead of sequentially can reduce overall test time by eliminating the time taken to reconfigure the system, and time to run tests in each axis.



Reproduction of failure modes

Three-axis simultaneous vibration testing reproduces real environments more accurately than sequential single-axis tests can.

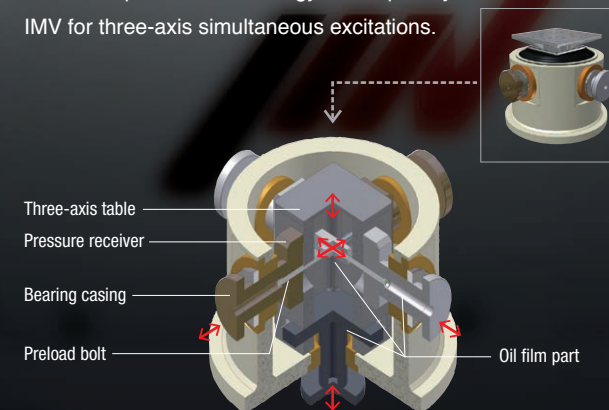


A single-axis system does not achieve realistic simulation of real-world vibration.

Simultaneous three-axis testing reproduces the stress placed on specimens by complex resonances which may not be detected in single-axis testing.

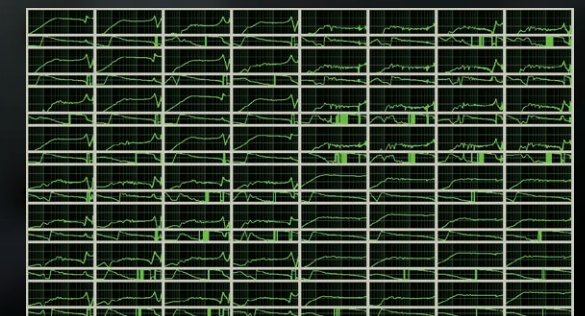
ICCU (Integrated Cross Coupling Bearing Unit)

ICCU is a patented technology developed by IMV for three-axis simultaneous excitations.



Highly accurate multi-axis multi-point control

High-precision multi-axis, multi-point control which can compensate for rotational moments generated by the specimen and fixture and accurately reproduce the vibration measured in the field.



DC-series

2-Axis Changeover Systems



DC-2000-5H

Specifications

System Model		DC-1000-4H	DC-1000-6H	DC-1000-8H	DC-1000-10M	DC-2000-5H	DC-2000-8M	DC-2000-10M	DC-2000-15M	DC-3000-5H	DC-3000-8M	
System Specifications	Table Size (mm)	□400	□600	□800	□1000	□500	□800	□1000	□1500	□500	□800	
	Rated Force	Sine (kN)	9.8	9.8	9.8	9.8	19.6	19.6	19.6	19.6	29.4	29.4
		Random (kN)	4.9	4.9	4.9	4.9	9.8	9.8	9.8	9.8	14.7	14.7
		Shock (kN)	14.7	14.7	14.7	14.7	29.4	29.4	29.4	29.4	44.1	44.1
	Maximum Acceleration (m/s ²)	108	75	54	32	150	81	67	28	196	140	
	Maximum Velocity (m/s)	1	1	1	1	1	1	1	0.9	1	1	
	Maximum Displacement (mmp-p)	51	51	51	51	51	51	51	51	51	51	
	Armature Mass (kg)	90	130	180	300	130	240	290	680	150	210	
	Maximum Frequency	Horizontal (Hz)	1000	800	700	350	800	500	350	250	800	500
		Vertical (Hz)	1000	1000	700	500	800	800	500	350	800	800
	Maximum Load (kg)	100	100	200	200	200	300	500	500	200	300	
	Power Requirements (kVA)	25	25	25	25	43	43	43	43	52	52	
Primary Cooling Water (ℓ/min)	-	-	-	-	-	-	-	-	-	-		

System Model		DC-3000-10M	DC-3000-15M	DC-5000-6H	DC-5000-8H	DC-5000-10M	DC-5000-15M	DC-6000-6H	DC-6000-8H	DC-6000-10M	DC-6000-15M	
System Specifications	Table Size (mm)	□1000	□1500	□600	□800	□1000	□1500	□600	□800	□1000	□1500	
	Rated Force	Sine (kN)	29.4	29.4	49	49	49	49	61.7	61.7	61.7	61.7
		Random (kN)	14.7	14.7	29.4	29.4	24.5	24.5	37	37	30.8	30.8
		Shock (kN)	44.1	44.1	73.5	73.5	58.8	58.8	92.5	92.5	74	74
	Maximum Acceleration (m/s ²)	91	47	350	204	163	59	385	268	102	75	
	Maximum Velocity (m/s)	1	0.9	1	1	0.9	0.9	1	1	0.9	0.9	
	Maximum Displacement (mmp-p)	51	51	51	51	51	51	51	51	51	51	
	Armature Mass (kg)	320	620	140	240	300	820	160	230	600	820	
	Maximum Frequency	Horizontal (Hz)	350	250	800	700	350	250	800	700	350	250
		Vertical (Hz)	500	350	1000	800	500	350	1000	800	500	350
	Maximum Load (kg)	500	500	300	300	500	700	300	300	500	700	
	Power Requirements (kVA)	52	52	75	75	73	73	93	93	91	91	
Primary Cooling Water (ℓ/min)	-	-	195	195	190	190	230	230	225	225		

*Depending on the reference PSD or other operating conditions such as the specimen, one part of the controlled response may deviate from the reference PSD. Please contact us for more information.

TC-series

3-Axis Changeover Systems



TC-3000-6H

Specifications

System Model		TC-1000-4H	TC-1000-6H	TC-1000-8H	TC-1000-10M	TC-2000-5H	TC-2000-8M	TC-2000-10M	TC-2000-15M	TC-3000-5H	TC-3000-8M	
System Specifications	Table Size (mm)	□400	□600	□800	□1000	□500	□800	□1000	□1500	□500	□800	
	Rated Force	Sine (kN)	9.8	9.8	9.8	9.8	19.6	19.6	19.6	19.6	29.4	29.4
		Random (kN)	4.9	4.9	4.9	4.9	9.8	9.8	9.8	9.8	14.7	14.7
		Shock (kN)	14.7	14.7	14.7	14.7	29.4	29.4	29.4	29.4	44.1	44.1
	Maximum Acceleration (m/s ²)	98	65	42	33	163	98	65	30	196	113	
	Maximum Velocity (m/s)	1	1	1	1	1	1	1	0.9	1	1	
	Maximum Displacement (mmp-p)	51	51	51	51	51	51	51	51	51	51	
	Armature Mass (kg)	100	150	230	290	120	200	300	640	150	260	
	Maximum Frequency	Horizontal (Hz)	1000	800	700	350	800	500	350	250	800	500
		Vertical (Hz)	1000	1000	700	500	800	800	500	350	800	800
	Maximum Load (kg)	100	100	200	200	200	300	500	500	200	300	
	Power Requirements (kVA)	27	27	27	27	43	43	43	43	52	52	
Primary Cooling Water (ℓ/min)	-	-	-	-	-	-	-	-	-	-		

System Model		TC-3000-10M	TC-3000-15M	TC-5000-6H	TC-5000-8H	TC-5000-10M	TC-5000-15M	TC-6000-6H	TC-6000-8H	TC-6000-10M	TC-6000-15M	
System Specifications	Table Size (mm)	□1000	□1500	□600	□800	□1000	□1500	□600	□800	□1000	□1500	
	Rated Force	Sine (kN)	29.4	29.4	49	49	49	49	61.7	61.7	61.7	61.7
		Random (kN)	14.7	14.7	29.4	29.4	24.5	24.5	37	37	30.8	30.8
		Shock (kN)	44.1	44.1	73.5	73.5	58.8	58.8	92.5	92.5	74	74
	Maximum Acceleration (m/s ²)	73	43	306	222	158	67	342	257	199	84	
	Maximum Velocity (m/s)	1	0.9	1	1	0.9	0.9	1	1	0.9	0.9	
	Maximum Displacement (mmp-p)	51	51	51	51	51	51	51	51	51	51	
	Armature Mass (kg)	400	680	160	220	310	730	180	240	310	730	
	Maximum Frequency	Horizontal (Hz)	350	250	800	700	350	250	800	700	350	250
		Vertical (Hz)	500	350	1000	800	500	350	1000	800	500	350
	Maximum Load (kg)	500	500	300	300	500	700	300	300	500	700	
	Power Requirements (kVA)	52	52	77	77	75	75	93	93	91	91	
Primary Cooling Water (ℓ/min)	-	-	195	195	190	190	230	230	225	225		

*Depending on the reference PSD or other operating conditions such as the specimen, one part of the controlled response may deviate from the reference PSD. Please contact us for more information.

DS-series

2-Axis Simultaneous Systems



DS-2000-4H

Specifications

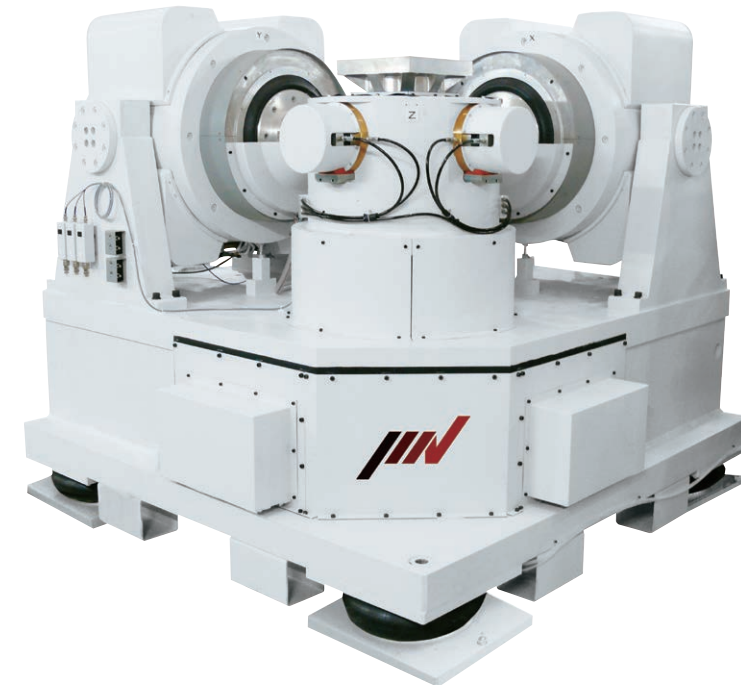
System Model		DS-1000-4H	DS-1000-6H	DS-1000-8H	DS-1000-10M	DS-2000-5H	DS-2000-8M	DS-2000-10M	DS-2000-15M	DS-3000-5H	DS-3000-8M	
System Specifications	Table Size (mm)	□400	□600	□800	□1000	□500	□800	□1000	□1500	□500	□800	
	Rated Force	Sine (kN)	9.8	9.8	9.8	9.8	19.6	19.6	19.6	19.6	29.4	29.4
		Random (kN)	4.9	4.9	4.9	4.9	9.8	9.8	9.8	9.8	14.7	14.7
		Shock (kN)	14.7	14.7	14.7	14.7	29.4	29.4	29.4	29.4	44.1	44.1
	Maximum Acceleration (m/s ²)	108	75	54	32	150	81	67	28	196	140	
	Maximum Velocity (m/s)	1	1	1	1	1	1	1	0.9	1	1	
	Maximum Displacement (mmp-p)	51	51	51	51	51	51	51	51	51	51	
	Armature Mass (kg)	90	130	180	300	130	240	290	680	150	210	
	Maximum Frequency	Horizontal (Hz)	1000	800	700	350	800	500	350	250	800	500
		Vertical (Hz)	1000	1000	700	500	800	800	500	350	800	800
	Maximum Load (kg)	100	100	200	200	200	300	500	500	200	300	
	Power Requirements (kVA)	30	30	30	30	66	66	66	66	76	76	
	Primary Cooling Water (ℓ/min)	-	-	-	-	-	-	-	-	-	-	

System Model		DS-3000-10M	DS-3000-15M	DS-5000-6H	DS-5000-8H	DS-5000-10M	DS-5000-15M	DS-6000-6H	DS-6000-8H	DS-6000-10M	DS-6000-15M	
System Specifications	Table Size (mm)	□1000	□1500	□600	□800	□1000	□1500	□600	□800	□1000	□1500	
	Rated Force	Sine (kN)	29.4	29.4	49	49	49	49	61.7	61.7	61.7	61.7
		Random (kN)	14.7	14.7	29.4	29.4	24.5	24.5	37	37	30.8	30.8
		Shock (kN)	44.1	44.1	73.5	73.5	58.8	58.8	92.5	92.5	74	74
	Maximum Acceleration (m/s ²)	91	47	350	204	163	59	385	268	102	75	
	Maximum Velocity (m/s)	1	0.9	1	1	0.9	0.9	1	1	0.9	0.9	
	Maximum Displacement (mmp-p)	51	51	51	51	51	51	51	51	51	51	
	Armature Mass (kg)	320	620	140	240	300	820	160	230	600	820	
	Maximum Frequency	Horizontal (Hz)	350	250	800	700	350	250	800	700	350	250
		Vertical (Hz)	500	350	1000	800	500	350	1000	800	500	350
	Maximum Load (kg)	500	500	300	300	500	700	300	300	500	700	
	Power Requirements (kVA)	76	76	104	104	106	106	126	126	128	128	
	Primary Cooling Water (ℓ/min)	-	-	370	370	360	360	440	440	430	430	

*Depending on the reference PSD or other operating conditions such as the specimen, one part of the controlled response may deviate from the reference PSD. Please contact us for more information.

TS-series

3-Axis Simultaneous Systems



TS-1000-4H

Specifications

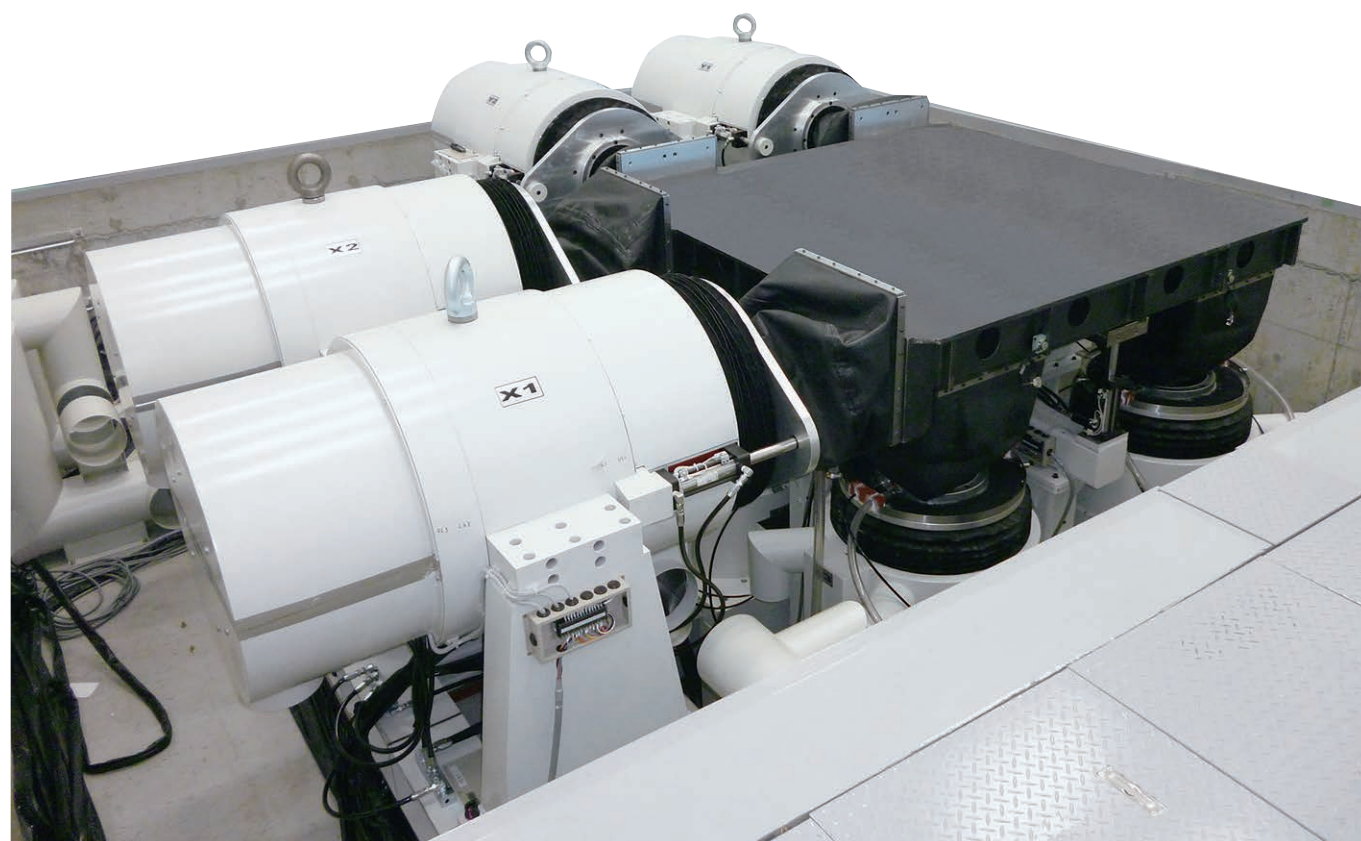
System Model		TS-1000-4H	TS-1000-6H	TS-1000-8H	TS-1000-10M	TS-2000-5H	TS-2000-8M	TS-2000-10M	TS-2000-15M	TS-3000-5H	TS-3000-8M	
System Specifications	Table Size (mm)	□400	□600	□800	□1000	□500	□800	□1000	□1500	□500	□800	
	Rated Force	Sine (kN)	9.8	9.8	9.8	9.8	19.6	19.6	19.6	19.6	29.4	29.4
		Random (kN)	4.9	4.9	4.9	4.9	9.8	9.8	9.8	9.8	14.7	14.7
		Shock (kN)	14.7	14.7	14.7	14.7	29.4	29.4	29.4	29.4	44.1	44.1
	Maximum Acceleration (m/s ²)	98	65	42	33	163	98	65	30	196	113	
	Maximum Velocity (m/s)	1	1	1	1	1	1	1	0.9	1	1	
	Maximum Displacement (mmp-p)	51	51	51	51	51	51	51	51	51	51	
	Armature Mass (kg)	100	150	230	290	120	200	300	640	150	260	
	Maximum Frequency	Horizontal (Hz)	1000	800	700	350	800	500	350	250	800	500
		Vertical (Hz)	1000	1000	700	500	800	800	500	350	800	800
	Maximum Load (kg)	100	100	200	200	200	300	500	500	200	300	
	Power Requirements (kVA)	41	41	41	41	94	94	94	94	110	110	
	Primary Cooling Water (ℓ/min)	-	-	-	-	-	-	-	-	-	-	

System Model		TS-3000-10M	TS-3000-15M	TS-5000-6H	TS-5000-8H	TS-5000-10M	TS-5000-15M	TS-6000-6H	TS-6000-8H	TS-6000-10M	TS-6000-15M	
System Specifications	Table Size (mm)	□1000	□1500	□600	□800	□1000	□1500	□600	□800	□1000	□1500	
	Rated Force	Sine (kN)	29.4	29.4	49	49	49	49	61.7	61.7	61.7	61.7
		Random (kN)	14.7	14.7	29.4	29.4	24.5	24.5	37	37	30.8	30.8
		Shock (kN)	44.1	44.1	73.5	73.5	58.8	58.8	92.5	92.5	74	74
	Maximum Acceleration (m/s ²)	73	43	306	222	158	67	342	257	199	84	
	Maximum Velocity (m/s)	1	0.9	1	1	0.9	0.9	1	1	0.9	0.9	
	Maximum Displacement (mmp-p)	51	51	51	51	51	51	51	51	51	51	
	Armature Mass (kg)	400	680	160	220	310	730	180	240	310	730	
	Maximum Frequency	Horizontal (Hz)	350	250	800	700	350	250	800	700	350	250
		Vertical (Hz)	500	350	1000	800	500	350	1000	800	500	350
	Maximum Load (kg)	500	500	300	300	500	700	300	300	500	700	
	Power Requirements (kVA)	110	110	149	149	153	153	182	182	182	186	
	Primary Cooling Water (ℓ/min)	-	-	550	550	530	530	650	650	640	640	

*Depending on the reference PSD or other operating conditions such as the specimen, one part of the controlled response may deviate from the reference PSD. Please contact us for more information.

TTS-series

6 Degrees of Freedom Systems

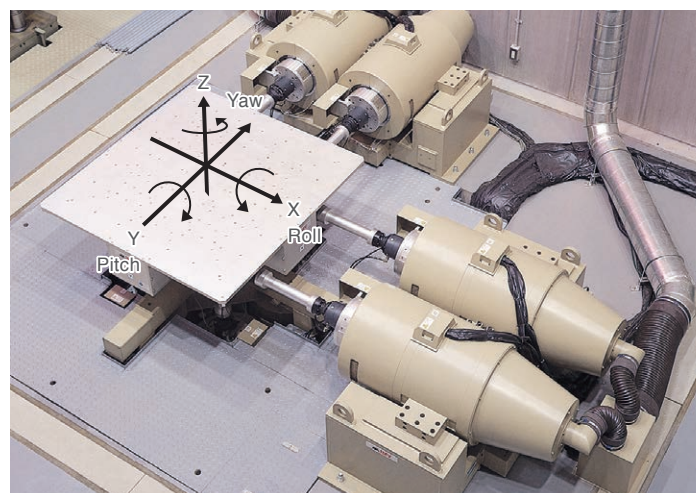


6 degrees of freedom systems

At least 6 vibration generators are located in 3D space with integrated control are employed to create or simulate 6 degrees of freedom motion (3 translation degrees of freedom and 3 rotating degrees).

In addition to X, Y, Z axis motion, rotational motion, Roll, Pitch and Yaw is also available utilising spherical bearings.

Using electro dynamic vibration generators, IMV systems can reproduce waveforms which have components in a wide frequency range with a high degree of accuracy. System maintenance is easy. Systems comprise at least six vibration generators to act along orthogonal axes and also to generate the roll, pitch and yaw components of vibration. The spherical bearings are used to allow such rotational motions. By using electrodynamic vibration generators the system can operate over a wide frequency range with a high degree of accuracy. No preparatory operation in necessary.



■ Ride comfort evaluation system

The addition of rotational motion to a three-axis system enables 6 degree-of freedom testing, as is required for vehicle seat evaluation, for example.



Excitation Direction	X axis	Y axis	Z axis
Rated Force (kN)	3.9	7.8	16
Maximum Displacement (mmp-p)	150	150	100
Frequency Range (Hz)	1-100		
Table Size (mm)	1800x1800		
Vibration Generator	1	2	4

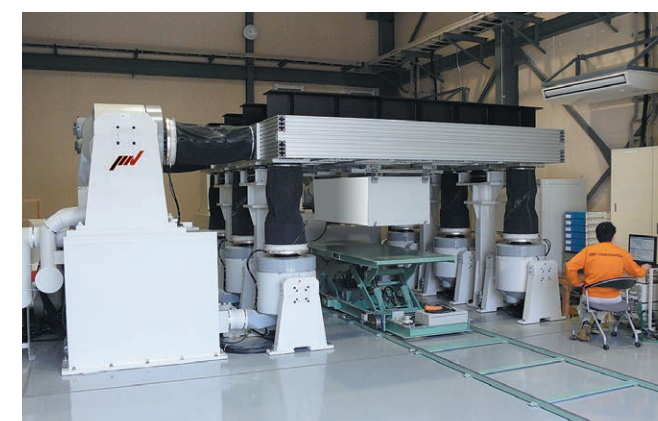
(Per 1 system)

Check the movie on YouTube



■ Large-scale 6 DOF vibration test system

A total of 10 vibration generators (6 vertical and 4 horizontal) and a 4000 mm by 3500 mm large size table allow the simultaneous 6 DOF vibration testing. This versatile platform is ideal for testing large items such as railway carriage components.



Excitation Direction	X axis	Y axis	Z axis
Rated Force (kN)	80	48	96
Maximum Displacement (mmp-p)	51		
Frequency Range (Hz)	2-150		
Table Size (mm)	4000x3500		
Vibration Generator	2	2	6

(Per 1 system)

■ 6 DOF simultaneous squeak and rattle test system for vehicle seats

Air-cooled vibration test system for the evaluation of squeak and rattle noise from an instrument panel or other car interior assemblies.



Excitation Direction	X axis	Y axis	Z axis
Rated Force (N)	1600	1600	3200
Maximum Displacement (mmp-p)	30		
Frequency Range (Hz)	5-100		
Table Size (mm)	1500x3500		
Vibration Generator	2	2	4

(Per 1 system)



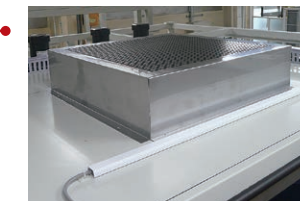
Vibration Test Systems Environmental Test Systems

Manufactured products can be exposed to both thermal and mechanical stresses.

These should not be considered separately, as the effects may be linked.

IMV can supply vibration-test systems combined with climatic chambers to provide complete vibration, temperature and humidity environmental testing. These systems can be custom-designed to meet your application.

Chamber for Vertical Excitation

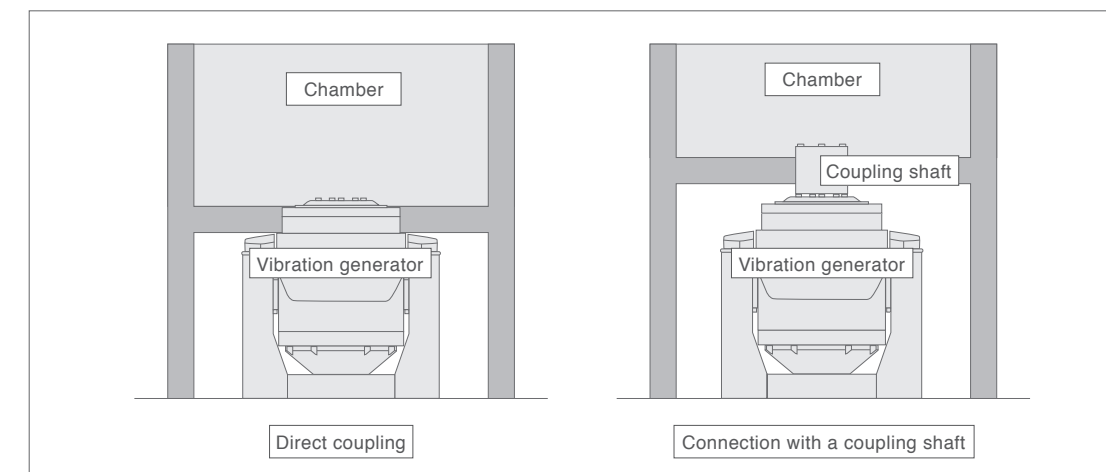


Inner pressure regulator: Reduce internal pressure fluctuation caused by vibration (Standard equipment)

Model : Syn-3HA-40-V

Internal dimensions	W1000xD1000xH1100 mm
Temperature range	-40 °C - +150 °C
Humidity range	20 % - 95 %RH
Temperature pull down time	+20 °C => -40 °C In 60 minutes (Curve gradient)
Temperature heat up time	-40 °C => +150 °C In 90 minutes (Curve gradient)

Docking image of combined systems



Model : Syn-6HW-30-V

Internal dimensions	W1800xD1900xH1500 mm
Temperature range	-30 °C - +80 °C
Humidity range	30 % - 95 %RH
Temperature pull down time	+45 °C => -30 °C In 35 minutes (Curve gradient)
Temperature heat up time	-30 °C => +80 °C In 25 minutes (Curve gradient)

Chamber for both Vertical and Horizontal Excitation

Horizontal slip table combined vibration test system.
Combining a rail support for horizontal move and a lift support for vertical move,
chamber combined test for both vertical and horizontal axis.

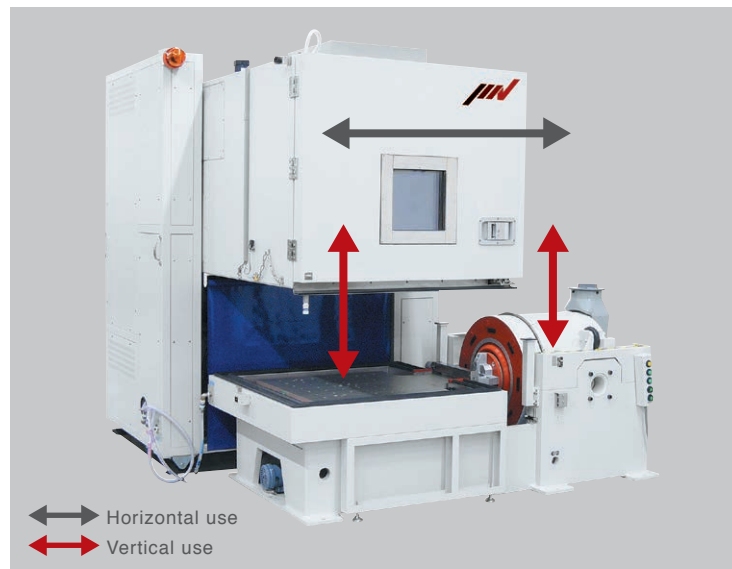


Vertical use



Horizontal use

■ Rail and lift support



Horizontal use
Vertical use

Model : Syn-3HA-70-VH

Internal dimensions	W1000xD1000xH1000 mm
Temperature range	-70 °C - +180 °C
Humidity range	20 % - 98 %RH
Temperature pull down time	1 °C/minutes or more (Curve gradient)
Temperature heat up time	2 °C/minutes or more (Curve gradient)



Check the movie
on YouTube

■ Option for chambers for both vertical and horizontal excitation

Optional crane

Adding a dedicated crane provides safe and simple loading and unloading of test specimens.



Optional crane and observation door

The vertical base can be attached and detached using the optional crane with the head expander straying mounted on the vibration generator. In addition, operator-friendly environment means such as observation door and body suspension automatic adjustment mechanism etc are equipped.



Side window

With a side window, chamber combination docking is possible with the specimen attached to the vibration generator for vertical excitation use.



Cable bear

Cables and water pipes put together with the cable bear provide safe work environment.



Chamber for Multi-Axis Excitation

Temperature, humidity chamber for multi-axis vibration test system.

Total test time can be reduced by eliminating conventionally needed time to reconfigure for testing each axis.

2-axis



Model : Syn-4HA-40-M

Internal dimensions	W1200xD1200xH1000 mm
Temperature range	-40 °C - +150 °C
Humidity range	20 % - 98 %RH
Temperature pull down time	+20 °C => -40 °C In 80 minutes (Load condition:combined + aluminum 60 kg)
Temperature heat up time	-40 °C => +150 °C In 80 minutes (Load condition:combined + aluminum 60 kg)

3-axis



Model : Syn-3HA-40-M

Internal dimensions	W1000xD1000xH1000 mm
Temperature range	-70 °C - +180 °C
Humidity range	20 % - 98 %RH
Temperature pull down time	+20 °C => -70 °C In 40 minutes (Curve gradient)
Temperature heat up time	-70 °C => +180 °C In 40 minutes (Curve gradient)

Prefabricated Chamber for Large Specimens

Large-sized specimen can be tested by a chamber combined test in both vertical and horizontal axis.

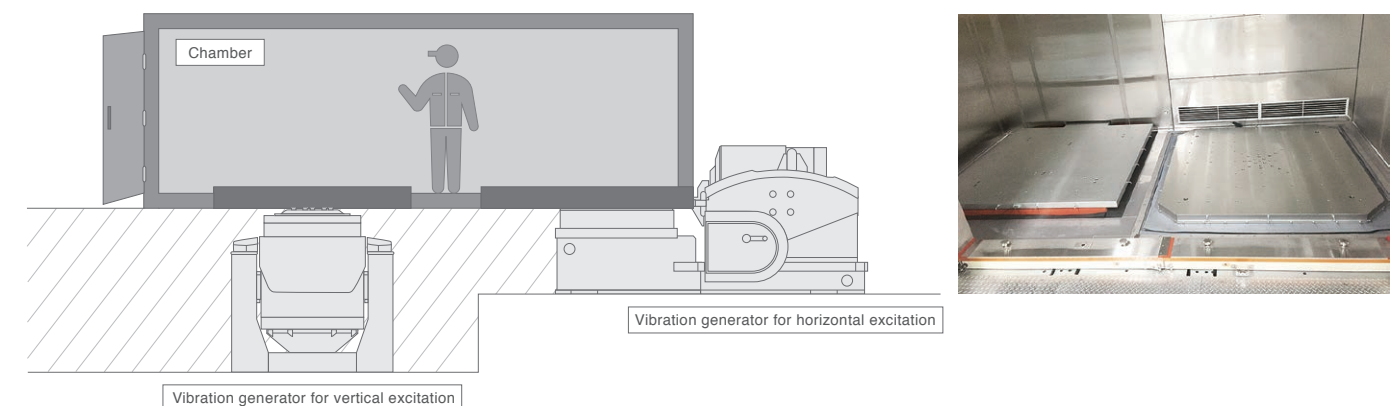


Model : Syn-6HA-40-VH

Internal dimensions	W4000xD2000xH2500 mm
Temperature range	-40 °C - +120 °C
Humidity range	30 % - 95 %RH
Temperature pull down time	+20 °C => -40 °C In 120 minutes (Curve gradient)
Temperature heat up time	-40 °C => +150 °C In 150 minutes (Curve gradient)



Docking image of combined systems

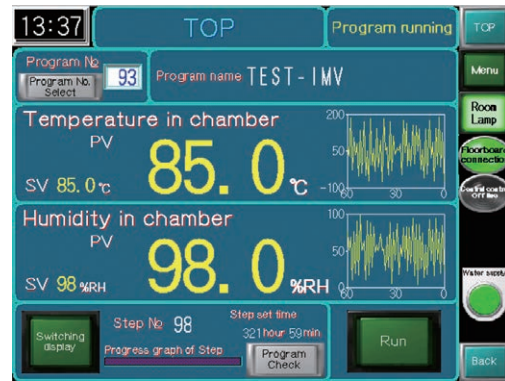


Climatic Chamber Controllers

Chamber controller

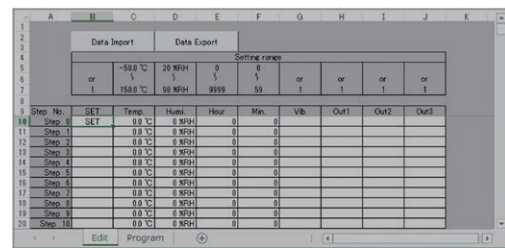
■ 8.4-inch touch panel

Clear display of information and buttons on the 8.4-inch touch-panel.



■ Program editable in PC

Setting-up a test can be performed using a spreadsheet. Programs use the standard CSV file format.



System monitor (option)

Connected to system monitor by Ethernet. The test status of both vibration generator and chamber can be monitored remotely.



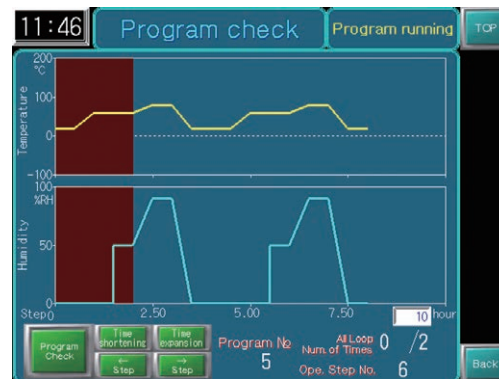
■ Program selection

Up to 100 programs can be stored in memory. Selecting the program to be used is straightforward.



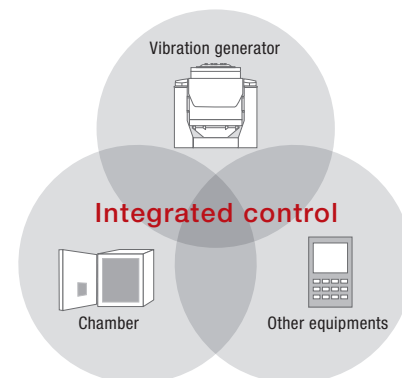
■ Program confirmation

Progress of the test is confirmed by tabular and graphical displays.



Integrated control system (option)

Vibration generator, chamber and other equipments can be controlled at one place.



Option

Many options are available to make easier such operation as different door positioning and observation window location.

■ Observation door

An observation door enables monitoring of the test specimen.



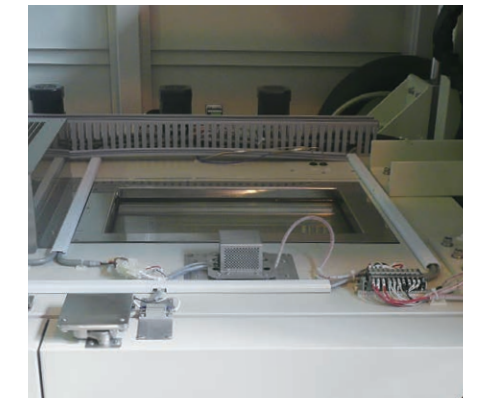
■ Infrared irradiation

Car instrumental panel, door, bumper, or body sections can be tested.

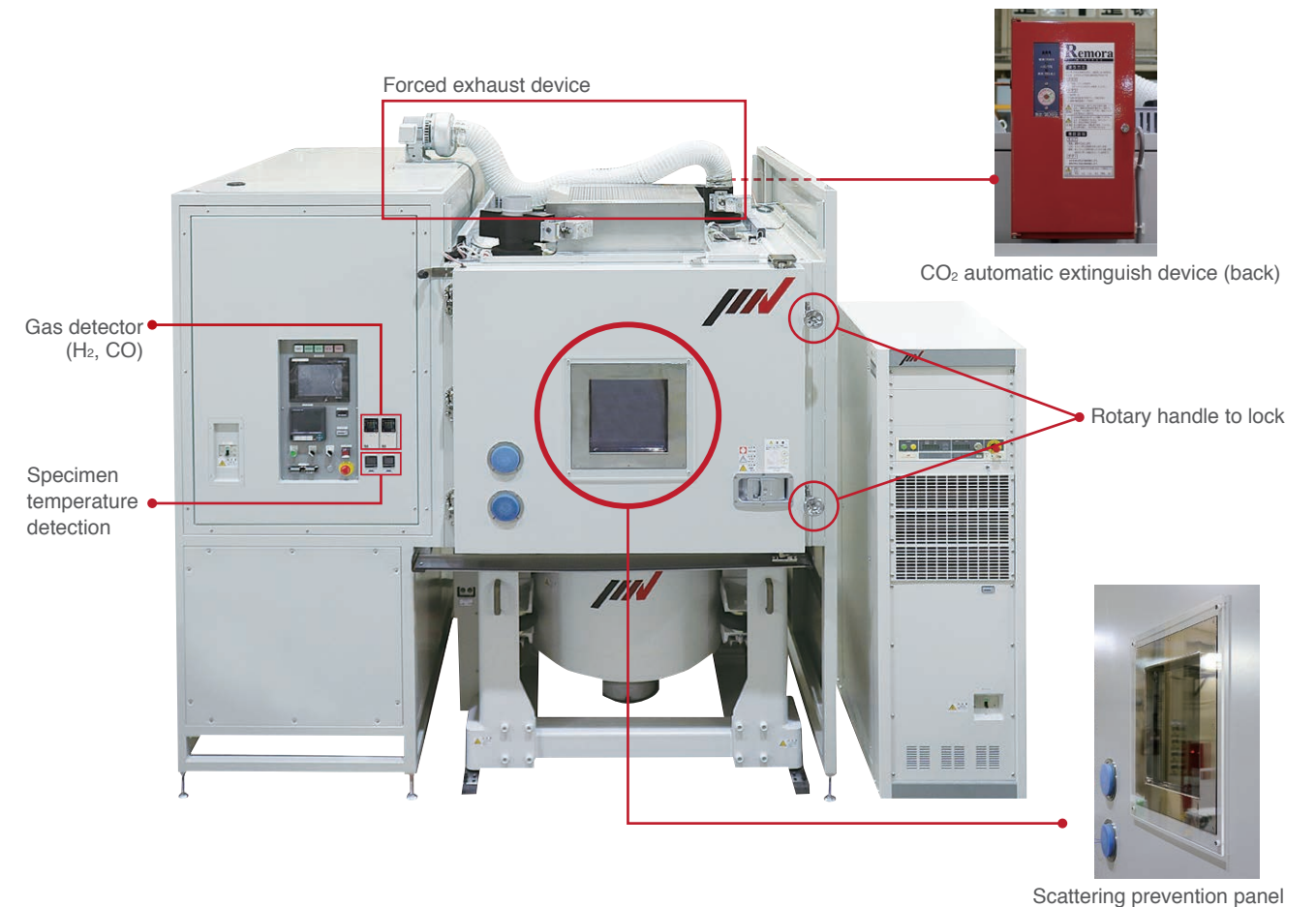


■ Ceiling observation window

A ceiling observation window allows full visibility of the vibration table and test specimen with no blind-spots.



■ Safety measures for fuel cell tests





Vibration Controller K2+

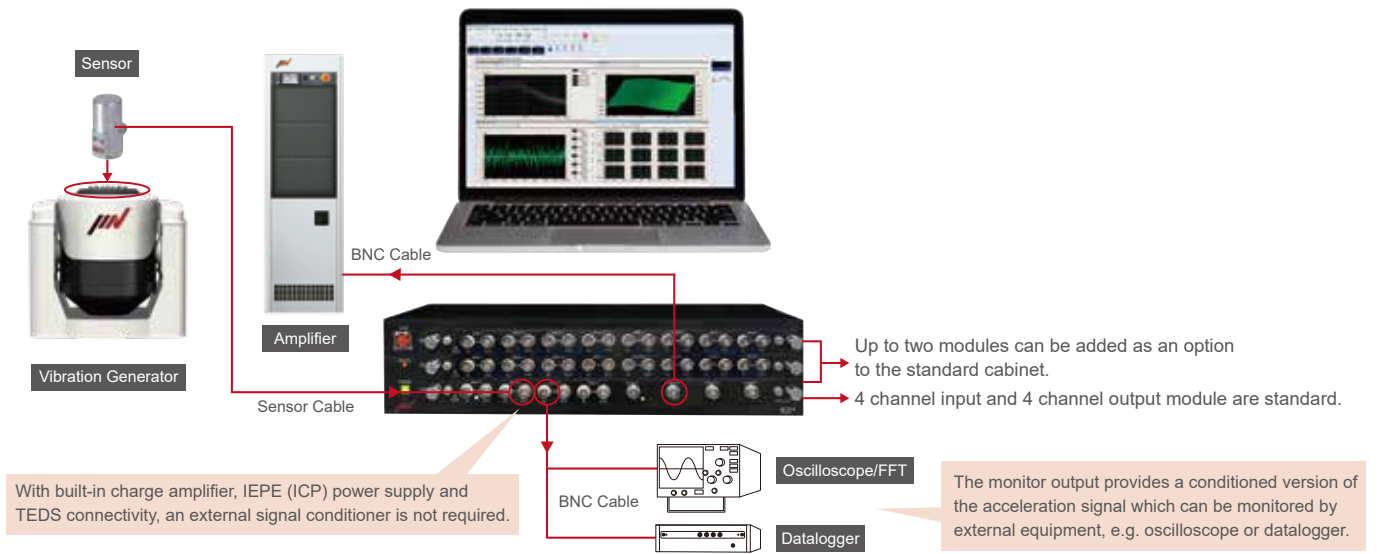
Common hardware supports all types of vibration test.

The K2+ controller provides the precision and repeatability required to test with confidence during both product development and series production. The K2+ hardware and software has been developed in-house, giving IMV full design control of this important part of a vibration system.

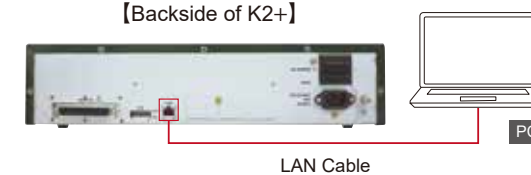
The K2+ system offers enhanced functions and operability based on the most advanced technologies and incorporating feedback from our customers.

Vibration Controller K2+

System Composition



[Backside of K2+]



Hardware Specifications

Main Enclosure	
Number of Slots	3
AC Power	Single-phase AC, 100 V-240 V (auto-selected)
External Communication	Contact I/O (for emergency stop)
Ambient Conditions	0-40°C, below 85% RH, non-condensing
Dimensions	W430 × H100 × D383 mm (not including projecting parts)
Mass	Approximately 7.0 kg

Minimum Specifications of PC

- One LAN port Gigabyte ethernet port and Gigabyte ethernet cable
- Microsoft Windows 10 Pro (64 bit) or Windows 10 IoT Enterprise (64 bit)*
- Memory required (for 8 input channels) 4 GB or more
- DVD-ROM Drive (required for installation)
- One USB port (necessary for protect device)
- Resolution of monitor and PC required 1280 x 1024 or more
- * Recommended OS and memory vary depending on software, options, number of I/O channels, etc.

*Please note that optional software "Program K2+" used for vibration controller K2+ also requires Japanese government export license (E/L).

	4-channel Input and 4-channel Output Module (standard)		8-channel Input Module (option)	
	4	8	8	
Input Section	Number of Channels	4	8	
	Input Connector	BNC		
	Input Signal	Charge, Voltage (Single-ended/Differential), IEPE		
	Charge Amplifier Sensitivity	1.0 mV/pC or 10 mV/pC		
	Charge Amplifier Cut-off	0.32 Hz		
	Maximum Input	Charge Input	±10000 pC or ±1000 pC	
		Voltage Input	±10000 mV	
		IEPE input	±10000 mV	
	Sampling Frequency	102.4 kHz maximum		
	Voltage Input Coupling	AC or DC		
AC Coupling Cut-off	0.1 Hz			
CCLD Amplifier (IEPE)	+24 VDC, 3.5 mA			
TEDS (IEPE)	Version 0.9, Version 1.0			
A/D Converter	Type	ΔΣ		
	Resolution	32 bit		
	Dynamic range	121 dB		
	Digital filter	Pass-band ripple: +0.001, -0.06 dB, Stop-band attenuation: 85 dB		
	Output Section	Number of Channels	4 (One channel is reserved for drive output)	
Output Connector		BNC		
Output Signal		Voltage		
Maximum Output		±10000 mV		
Sampling Frequency		102.4 kHz maximum		
D/A Converter		Type	ΔΣ	
	Resolution	32 bit		
	Dynamic range	120 dB		
	Digital filter	Pass-band ripple: ±0.005 dB Stop-band attenuation: 100 dB		

■ Intuitive Operation

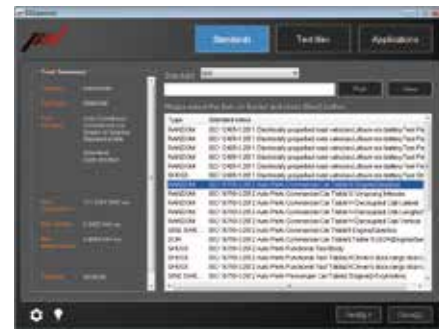
Launcher



Easily-recognised icons are used for file management.

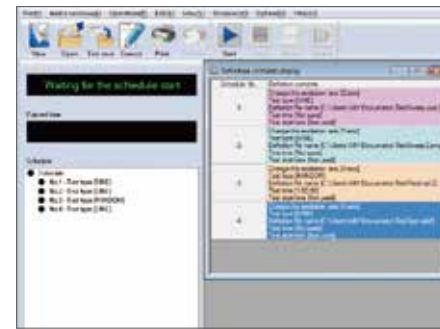
Test standard

* Standard for A-series and K-series



A test file will be automatically generated upon selection of the test conditions defined by the test standards.
*Please refer to the following for the test standards.

Scheduler



Several different tests types are executed automatically and in sequence according to the pre-defined schedule.

■ Optional Test Standard

The main test standards stored in the Launcher software (Ver 22.2.0.0 onwards) are as follows as of December 2022. The Launcher software is an option for the K2.

JIS C 60068	Sine, Random, Shock
JIS D 1601	Automotive parts simulated long-life test
JIS E 4031	Railway vehicle parts functional test, Simulated long-life test
JIS Z 0200	Transportation test
JIS Z 0232	Transportation test (Random)
JASO D 014	Automotive parts functional test
ASTM	Transportation test
UN	Lithium-ion battery test recommended by UN
ISO16750	Automotive parts test
ISO12405	Electric vehicle
IEC60068	Sine, Random, Shock
IEC62660	Random, Shock for secondary lithium-ion cells of electric vehicles
ISTA	Transportation test
IEC61373	Railway vehicle parts functional test
ISO13355	Transportation test (Random)
ISO4180	Transportation test
ISO19453	Electric vehicle parts
JIS E 3014	Parts for railway signal
EIA 364	Electrical connector performance test

*Version upgrade will incur an additional cost.

■ K2 Related Products

K2 Sprint



Mass: Approx. 2.0 kg

While inheriting all of the performance and features of K2, K2 Sprint offers improved cost-effectiveness with 2-channel hardware. K2 Sprint is best-suited to single monitor-channel operation.

Differences from K2 • Input 2 channels (No expansion) • Output 2 channels (No expansion)

K2/SINE Manual Test Remote Control Box (Option)



A control box for remotely controlling digital vibration controller K2/SINE. The unit includes push buttons for test start and stop, and rotary controls for manually adjusting vibration frequency and acceleration.

■ Optional Software

Non-Gaussian

Random test application that can reproduce accurate vibrations closer to the real environment Actual vibrations such as transport vibrations are often non-Gaussian random vibrations in which large peaks are generated. The K2 Non-Gaussian application accurately reproduces real-world vibration having a non-Gaussian amplitude distribution.

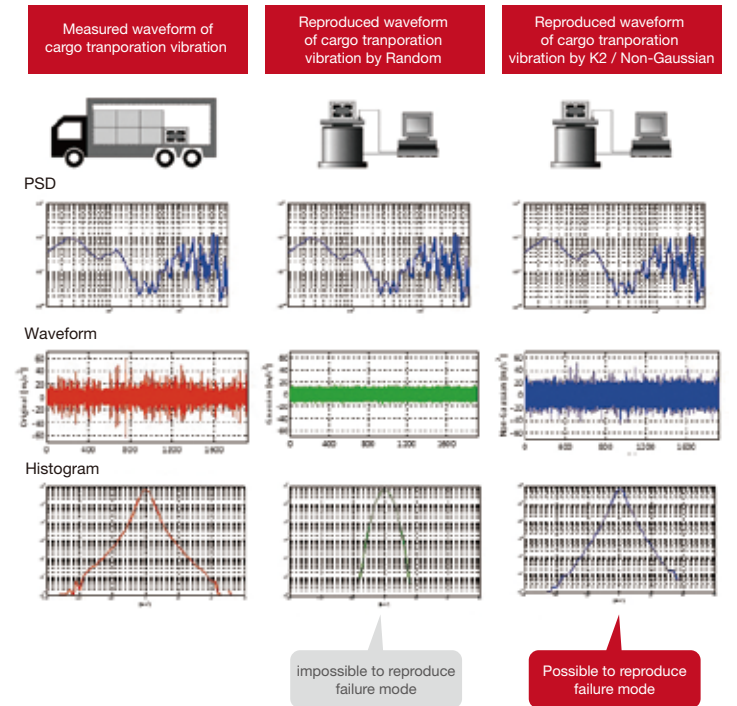
Effectiveness of non-Gaussian random vibration testing

The figures on the right explain the effect of using Gaussian Random and Non-Gaussian Random control in a vibration test based on the replication of vibration measured while driving on a highway. The PSD and rms value of the three waveforms are the same.

It is clear that the vibration reproduced by “K2/Non-Gaussian” is closer to the real measured vibration than the vibration reproduced by “Standard Random”.

Generally, the greater the acceleration, the greater the impact on the product, but “K2/Non-Gaussian” can accurately reproduce this characteristic of real-world vibration.

It can be stated that “K2/Non-Gaussian” can simulate fatigue which is closer to the real environment experienced by the product than a “Standard Random” test in this example.

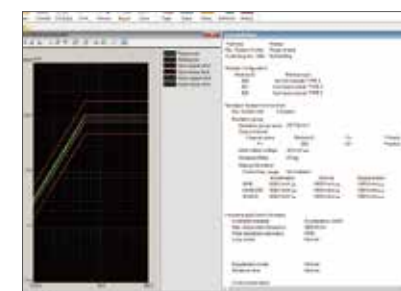


impossible to reproduce failure mode

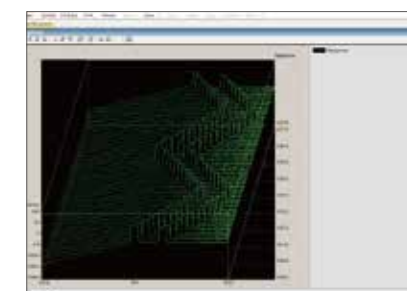
Possible to reproduce failure mode

K2 DataViewer Free software

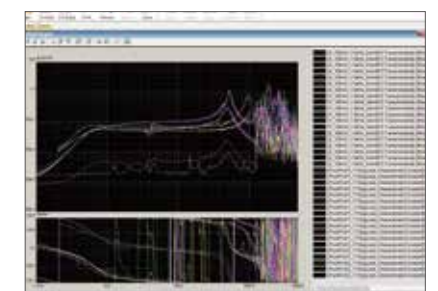
It is the software to display result data file saved after the test of SINE, RANDOM and SHOCK. It can be used for display of test condition, result graph, or for comparison between past test data (overlapping display), generation of reports.



Test condition, result graph



3D graph



Overlapping display



Report

■ System Requirement

[Supported OS]

Windows 10 (64 bit) , Windows 7 (32 bit/64 bit)

[Memory]

More than 512 MB of RAM is recommended

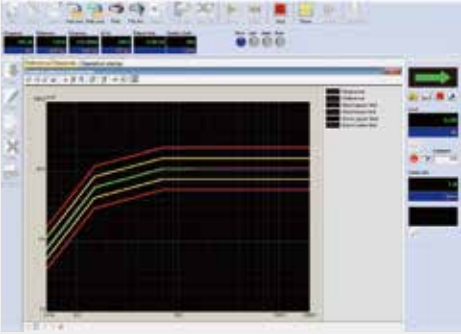
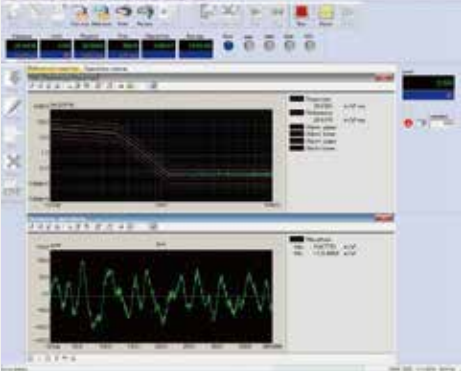
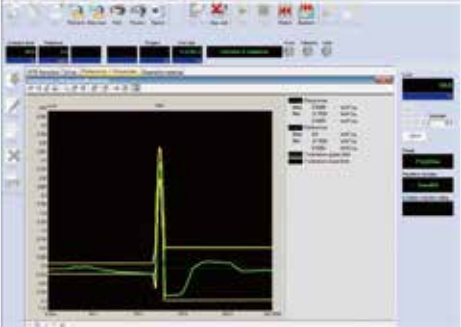
[Hard Disk]

More than 200 MB of free space is required




Application site

■ Software

Basic Software	Specifications	Optional software
<p>SINE</p> 	<ul style="list-style-type: none"> • Control Algorithm Continuous closed-loop control of true rms level • Control Frequency Range 0.1-20000 Hz • Control Dynamic Range More than 120 dB • Operation Modes 1) Continuous sweep, Spot, Manual 2) Closed-loop, Open-loop • Measurement Method Average, RMS, Tracking • Multiple-Channel Control Modes Average control, Maximum control, Minimum control • Input Channels Maximum 20 <p>*Specifications may be affected by other conditions</p>	<ul style="list-style-type: none"> • R_DWELL: Resonance Dwell Resonance is detected by measuring the phase difference between the control point and the response signal from a resonant part of the item under test. The test frequency is controller to maintain resonance as the structure fatigues. After holding at the resonance for a pre-defined duration, sweeping can be resumed, until the next resonance is detected. • A_DWELL: Amplitude Dwell A transmissibility plot is taken from two points on the structure under test and resonances listed. A sine test can then be run at each resonant frequency, with tracking of the resonance by either amplitude or phase. • LIMIT CONTROL Response channels can be specified as limit control channels. If the level on a limit control channel would exceed its limit, the test level is reduced accordingly. • Multi Sweep Sine A traditional wide-band sine sweep is divided into several narrower-band sine sweeps, which when added together combine to cover the original wide band. Running the narrow band sweeps in parallel significantly reduces the test time required.
<p>RANDOM</p> 	<ul style="list-style-type: none"> • Control Algorithm Closed-loop control of PSD within each spectral line • Control Frequency Range 20 kHz Maximum • Number of Control Lines Maximum 25600 lines • Control Dynamic Range More than 98 dB • Loop Time 200 ms (fmas = 2000 Hz, at L = 400 line) • Multiple-Channel Control Modes Average control, Maximum control, Minimum control • Input Channels Maximum 20 <p>*Specifications may be affected by other conditions</p>	<ul style="list-style-type: none"> • SOR: Sine on Random Random vibration and sine vibration frequencies are combined. Sine vibration can be swept. • ROR: Random on Random Broad-band random combined with sweeping or non-sweeping narrow-band random overlaid. • EXTENDED ROR The extended ROR makes it possible to operate an ROR test with greater freedom when defining separate NBR references. • PSD LIMIT: PSD limit control Response channels can be specified as limit control channels. If the PSD on a limit control channel would exceed its limit, the test level is reduced over that range of frequencies to keep with the limit level • Non-Gaussian It is a vibration testing method which precisely reproduces non-Gaussian vibration such as transportation vibrations with large spikes. • Soft-Clipping A clipping function that can reduce the peak value of the output voltage without affecting control performance.
<p>SHOCK</p> 	<ul style="list-style-type: none"> • Control Algorithm Finite-length waveform controlled by feed forward method • Control Frequency Range Maximum 20000 Hz • Number of Control Lines Maximum 25600 lines • Control Dynamic Range More than 98 dB • Type of Reference Waveform Classical shock waveform (Half-sine, Haversine, Saw-tooth, Triangle, Trapezoid etc.), Sine beat waveform, Measured waveform etc. • Input Channels Maximum 20 <p>*Specifications may be affected by other conditions</p>	<ul style="list-style-type: none"> • LONG WAVEFORM The length of a reference waveform is 16 K points as standard. This can be increased to 200 K points by adding the LONG WAVEFORM option. At a sampling frequency of 512 Hz for example, this produces approximately 6.5 minutes of waveform, compared to the standard length of approximately 30 seconds. • MEGAPOINT A further increase in waveform duration can be obtained by adding the MEGAPOINT option to the LONG WAVEFORM option. This increases the record length to 5000 K points, about 163 minutes at 512 Hz sampling rate. • SRS: Shock Response Spectrum SRS (Shock Response Spectrum) can execute the test in which the test condition and evaluation are conducted not based on waveform itself, but on SRS analysis. With standard shock test selected, SRS analysis of response waveform is also possible.

■ Software

Basic Software	Specifications	Optional Software
<p>Multi SINE</p> 	<ul style="list-style-type: none"> • Control Algorithm (Three modes of control) 1) Amplitude: Continuous closed-loop control of true rms level 2) Phase: Real-time waveform controlled by feed forward method 3) Monitoring and minimising of cross-axis component • Control Frequency Range 0.1-10000 Hz • Frequency Resolution Better than 10⁻⁴ of frequency • Control Dynamic Range More than 120 dB • Operation Modes 1) Continuous sweep, Spot test 2) Control and monitoring in various physical units • Estimation Method Average, RMS, Tracking • Multiple-Channel Control Modes Average control, Maximum control, Minimum control • Input Channels Maximum 20 (Maximum 20 chs for principal control channel) • Output Channel Maximum 12 <p>*Specifications may be affected by other conditions</p>	<ul style="list-style-type: none"> • LIMIT CONTROL If a response point is specified to be a limit control channel, the level of that response point will not exceed the level specified in the test.
<p>Multi RANDOM</p> 	<ul style="list-style-type: none"> • Control Algorithm (Three modes of control) 1) PSD of random signal closed loop control by spectrum density for each frequency segment 2) Real-time waveform controlled by feed forward method 3) Monitoring and minimising of cross-axis component • Control Frequency Range Maximum 10000 Hz • Number of Control Lines Maximum 3200 lines • Control Dynamic Range More than 98 dB • Loop Time 450 ms (3-input, 3-output control, 120 DOF, fmax = 2000 Hz, L = 200 line cross-talk information averaging times = 8 times/loop) • Multiple-Channel Control Modes Average control, Maximum control, Minimum control • Input Channels Maximum 20 (Maximum 20 chs for principal control channel) • Output Channel Maximum 12 <p>*Specifications may be affected by other conditions</p>	<ul style="list-style-type: none"> • PSD LIMIT CONTROL If a response point is specified to be a limit control channel, the level of PSD doesn't exceed the specified PSD level in the test. • Non-Gaussian It is a vibration testing method which precisely reproduces non-Gaussian vibration such as transportation vibrations with large spikes.
<p>Multi SHOCK</p> 	<ul style="list-style-type: none"> • Control Algorithm Finite-length waveform controlled by feed forward method • Control Frequency Range Maximum 20000 Hz • Number of Control Lines Maximum 25600 lines • Control Dynamic Range More than 98 dB • Type of Reference Waveform Classical shock waveform (Half-sine, Haversine, Saw-tooth, Triangle, Trapezoid etc.), Sine beat waveform, Measured waveform etc. • Length of Reference Waveform Maximum 5000 k points • Input Channels Maximum 32 • Output Channel Maximum 32 <p>*Specifications may be affected by other conditions</p>	<ul style="list-style-type: none"> • SRS: Shock Response Spectrum SRS (Shock Response Spectrum) can execute the test in which the test condition and evaluation are conducted not based on waveform itself, but on SRS analysis. With standard shock test selected, SRS analysis of response waveform is also possible.

Common optional software	Outline	
CAPTURE: Analogue waveform signal data program	Provides analogue waveform signal capture, saved data can then be used as the reference of SHOCK, BMAC waveform controls or Random vibration PSD control.	<ul style="list-style-type: none"> • Sampling Frequency: 51.2 kHz maximum • Data Length: Maximum 5000 k points • Input Channel: Maximum 24 • Waveform edit/analysis function: Filtering, Frequency transfer processing, PSD transfer, Transmissibility ratio between channels
SCHEDULER: Test scheduler	Pre-defined tests can be executed in sequence.	
TCP Communication Server	TCP communication server software that allows external applications to operate K2 applications and acquire vibration data and operating status by sending and receiving commands via TCP/IP.	



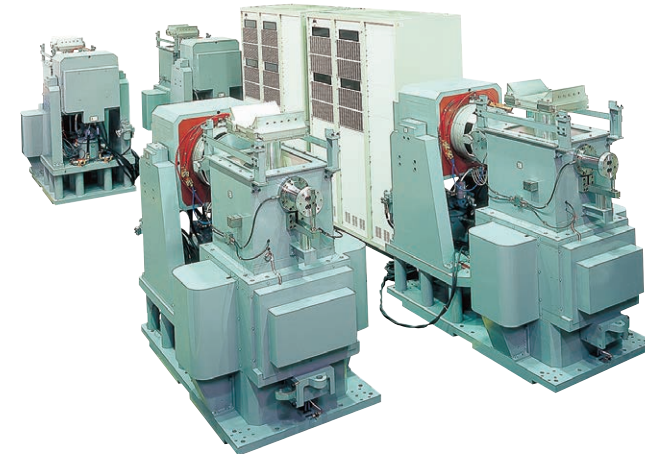
With IMV's approach to a more realistic reproduction of the vibration environment, IMV is focused on producing products that are customised to the specific needs of our customers. IMV is proud of our continuous contribution to improvements in product safety and comfort for the wider society through increasing product reliability as a "solution partner" for all industries.

Customised Products [Case Studies]

Customised Products

Automotive Parts

Case Studies



Electrodynamic multi-axis 4 poster system

Accurate waveform reproduction is achieved over a wide frequency range up to 500 Hz by employing electrodynamic vibration generators.



3-axis simultaneous vibration test system

Test systems for the automotive tyre industry, used for evaluating the transfer characteristics of a tyre at varying air volumes and ride comfort.



Torsion vibration test system

By installation of compact vibration generators on the top of a multi-axis test system and exciting both systems simultaneously, reproduction of 'real road' 6-DOF and torsion is achieved.



Low cross axis motion vibration test system

Ensures low cross axis motion, equipped with the mechanism to match the center gravity of the assembly of specimen + fixture (+ slip table) to the excitation axis by up and down of the table support bearing assembly.

Customised Products

Automotive Parts

Case Studies



6-DOF vibration test system

Evaluate road noise generated by a car by placing the test system under the wheel of the car and generating vibration of 6-DOF nature in to one wheel.



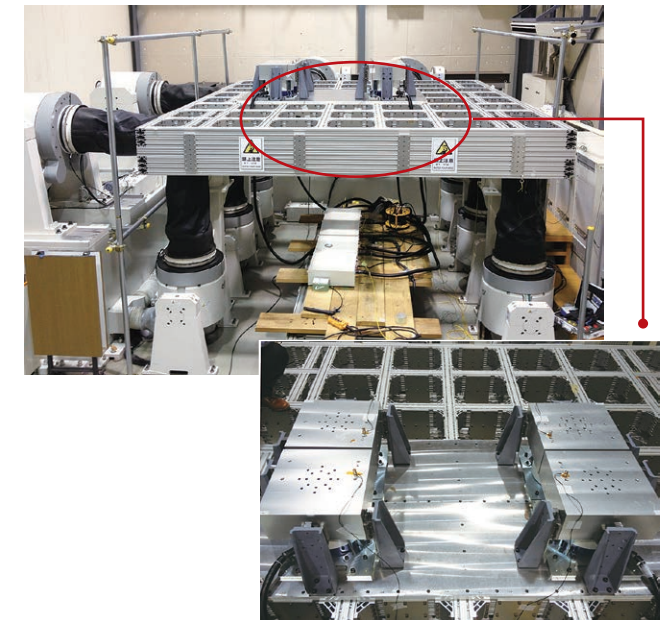
6-DOF large vibration test system

Reproduction of ultimate vibration realism for testing ride comfort of car seats with a 6-DOF vibration test system.



Diagonal excitation vibration test system

Diagonal excitation for two-wheeled vehicles. Angle of rotation for the vibration generator can be adjusted in 1 degree increments.



Torsion test system (6 DOF + Torsion vibration test system)

6 DOF vibration test with measured running data is possible. Torsion on car body during running can be simulated. Torsion exaction for car equipment.



200 mm peak-to-peak displacement vibration test system

System is particularly suited for applications requiring high velocity at low frequencies. The system has a high over-turning moment due to 4 linear guide bearings, allowing test of specimens with a large offset centre of gravity.



6-DOF simultaneous squeak and rattle test system for instrument panels

6-DOF vibration test system with 8 compact, silent type shakers for squeak and rattle acoustic noise evaluation of instrument panels.



Environmental test system

Environmental test system combining vibration, temperature, gasoline circulation, oil circulation and rotational drive.



Exhaust system durability testing

Durability testing with hot air and vibration. Air temperature range from 200 °C to 900 °C, air flow from 2 to 10 m³/min provided from a hot air generator is applied into the exhaust system.

Customised Products

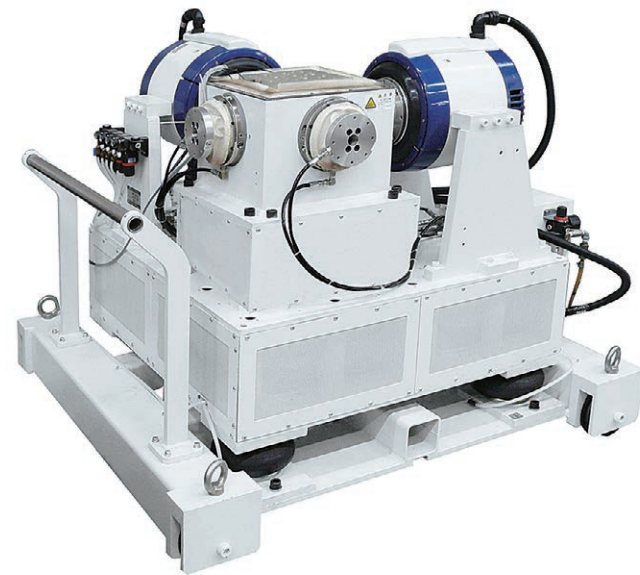
Automotive Parts

Case Studies



Dynamic spring constant measuring system

Highly accurate testing and analysis are possible over a wide frequency range from 1 Hz up to 2000 Hz.



Low acoustic noise 3-axis vibration test system + guide rail

Vibration test system can move along the guide rails. The system can be combined with other test equipment if necessary, for example a temperature chamber.



2-axis climatic chamber combined vibration test system

Double-sided door makes easy to reach the specimen. Equipped with temperature alarm meter for surface temperature monitoring and CO₂ automatic fire extinguisher.
Sine: 1000 Hz, Random: 2000 Hz,



3-axis simultaneous vibration test system

Simultaneous 3-axis vibration test system designed for earthquake resistance test and earthquake regeneration. Vibrations in three directions can be simultaneously applied to the specimen.



Low acoustic noise 3-axis vibration test system

Simulation testing using actual measured data or more traditional random testing is possible in 3-axis simultaneous excitation. When combining the shaker system with a half anechoic room, 3D squeak and rattle testing in an environment with a background noise level of less than 30 dB is possible.



Vertical / Horizontal changeover chamber combined vibration test system

Used for durability testing of on-board battery chargers and inverters/DC-DC converters for electric cars. Vertical and horizontal excitation, both combined with a chamber, is possible.



Ultra-high temperature (900°C) chamber combined single axis vibration test system

Applicable to temperature and humidity environmental testing for products which may be exposed to ultra-high temperature up to 900 °C. Employs the virtual point control method to control acceleration of the specimen in the chamber without accelerometers mounted.



Compact chamber combined vibration test system

Function tests and durability tests of parts exposed to sudden temperature change are possible.

Customised Products **Electronic Parts**

Case Studies



Sensor calibration vibration test system

Pure single-axis vibration which is very hard to generate with a conventional single-axis system. 4 vibration generators are located orthogonally to the major axis to cancel unwanted cross-axis acceleration.



High frequency vibration test system

Combining 4 low-noise compact vibration test systems with a chamber and using multi-point control, vibration excitation combined with a climatic test is achieved from 2 kHz up to 10 kHz.



Environmental test system

Large area heat resistance glass (-40°C - 110°C) is provided for checking the specimen inside the chamber during a combined test. To reduce the required installation space, a guide rail system is used with for the vibration test system and horizontal slip table.



Crimping terminal evaluation system

Setup time is reduced with a dedicated fixture for various sizes of crimping terminal. 8 to 20 samples can be evaluated at one time.

Customised Products **Transportation Test**

Case Studies



Underslung 6-DOF vibration test system (Railway testing)

A combination of 10 vibration generators (6 vertical and 4 horizontal) and a 4,000 mm by 3,500 mm large-scale moving table allowing simultaneous, multi-point vibration testing. This versatile vibration platform is ideal for testing large items such as railway carriage parts and fuel cells.



3-axis large vibration test system for transportation simulation

Vibration test system for very large specimens. Moving table size is 3,000 mm x 2,000 mm composed of 2 off 125 kN shakers for the X and Y axes and 2 off 60 kN shakers for the Z axis.



3-axis simultaneous vibration test system

Simultaneous, multi-axis vibration data acquisition with IMV's vibration measurement unit built in to a railway container. Data is subsequently used for a real waveform 3-axis simultaneous vibration test.

Watch the YouTube video



2-axis large vibration test system

Table size 2000 x 2500 mm, Maximum load 2000 kg. Transportation test for large specimens or vibration durability test.

Customised Products

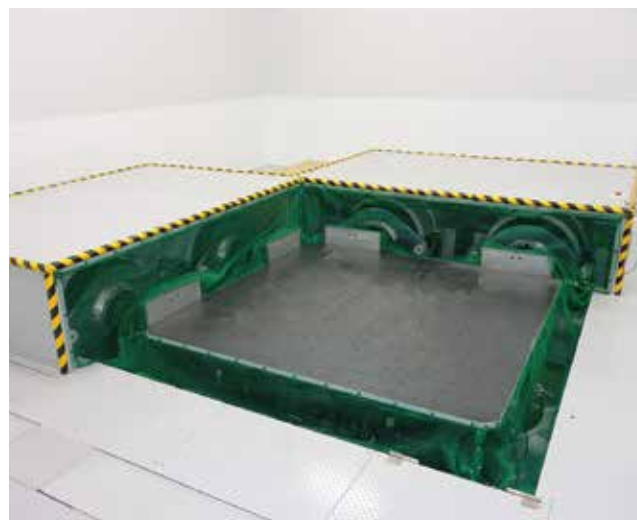
Construction Machinery

Case Studies



Energy saving type vibration test system with large size slip table

Maximum load is 2,000 kg. (when used with the lateral load reinforcement guide or slip table). The built-in automatic ECO function optimizes power consumption across all vibration test types.



6-DOF vibration test system

Durability testing with real measured waveforms for excavator cabins or heavy machinery tanks. The system reproduces vibration in X,Y, Z axes as well as roll, pitch and yaw.



3-axis changeover vibration test system

Once the specimen and fixture are set, it is possible to switch the X/Y/Z axis excitation automatically. No time is spent remounting specimens or assemblies. Tests can be easily continued without time loss.



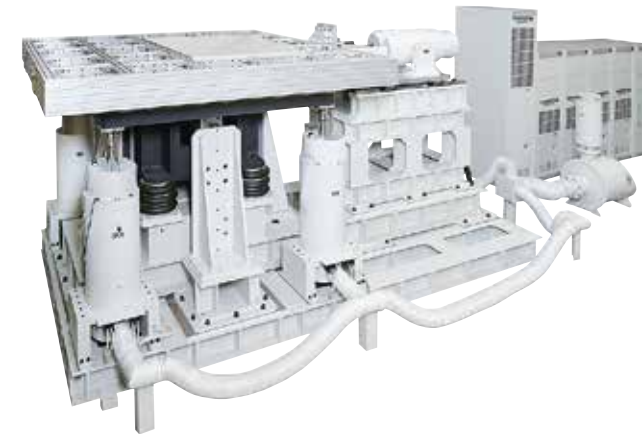
Large vibration test system for high frequency testing (up to 5000 Hz)

For high-frequency tests with large specimens. The slip table can be replaced according to the size of the specimen and each table can be used for high-frequency testing.

Customised Products

Earthquake Resistance

Case Studies



Large scale earthquake resistance vibration test system

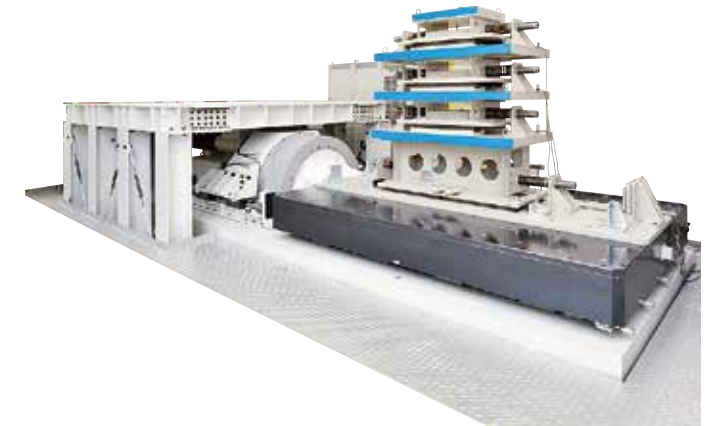
The unique hybrid method achieves accurate reproduction of both large-displacement and high-frequency waveforms by utilising the benefits from an electrodynamic vibration generator and an AC servomotor.

Watch the YouTube video



Large 2-axis simultaneous, multi-point excitation vibration test system

Large vibration test system with a table size of 4500 mm x 4500 mm. Rated displacement: 400 mm peak-to-peak horizontal, 200 mm peak-to-peak vertical. Maximum load of 20 ton.



Large scale earthquake resistance vibration test system

An industry first, hybrid technology low-frequency vibration test system which simulates highly accurate waveforms including high- and low-frequency components simultaneously with an electrodynamic shaker and AC servomotor.

Watch the YouTube video



Earthquake resistance vibration test system for seismic switches

Hydraulic bearing (Type TT) makes it possible to achieve a waveform reproduction error ratio within 2% using only 2 or 3 drive signal updates. Maximum displacement: 150 mmp-p Frequency range: 0.5 – 20 Hz

Customised Products **Aerospace**

Case Studies



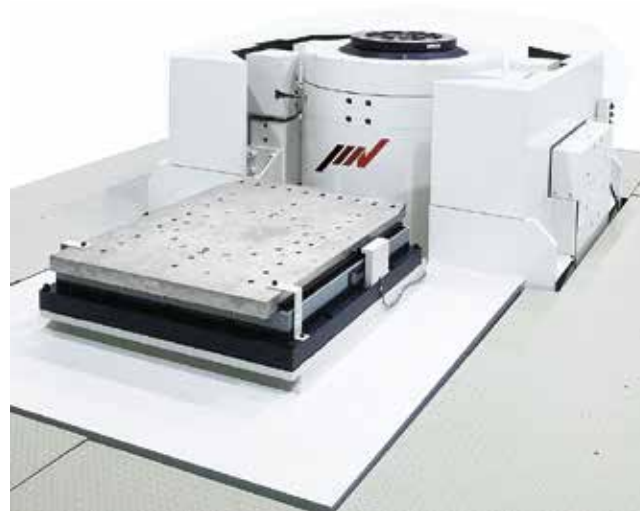
350 kN large water cooled vibration test system

Watch the YouTube video



One of the world's largest excitation force systems, with a distinctive 76.2 mm p-p (3 inches) alternative displacement rating.

High-velocity shock tests of 3.5 m/s are also possible.



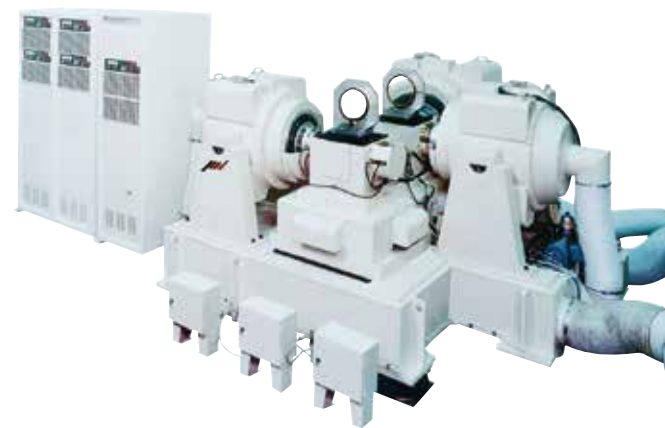
Large-scale 200 kN vibration test systems for the aerospace industry

With low displacement requirements for the aerospace industry, this system is fitted with a Team slip table using the T-Film bearing. High over-turning moment and low cross-axis acceleration are features of this system in both vertical and horizontal operation.



Vibration test systems for clean rooms

The air inlet and outlet for the shaker are ducted from outside of the clean room; this maintains the cleanliness of the room.



Multi-point, multi-axis vibration test system

Multi-point vibration test system with three-axis simultaneous excitation. The system has the capability to carry out tests of very long specimens over a high frequency range.

Customised Products **etc. Other Applications**

Case Studies



Vibration test system for fatigue testing of copper plate

Especially developed for the fatigue testing of copper plating by customizing a compact shaker from IMV's m-series. Simultaneous testing of 12 sheets of copper plating is possible with this compact system.



Vibration test system with acid-resistant table

A standard specification slip table with alumite coating (as an example) is not suitable for vibration testing in the battery industry due to damage caused by leaking battery chemicals. A specially-formulated coating for the slip table is applied which is resistant to battery leaks.



Adopted by JQA (Japan Quality Assurance Organization)

Compact vibration test system for sensor calibration

This system realizes low distortion in low-frequency and low-acceleration areas and is used as a calibrator at JQA and other public institutions.



Pressure-proof flexible duct endurance test

The neutral position of the horizontal slip table can be adjusted and the slip table displacement is controlled as well. This allows a specimen to be permanently and rigidly fixed on one side and mounted on the slip table on the other side.

Technical Guidance

For installation of vibration test systems

Basic units used for vibration test

There are four important units for a vibration test. Force [N], Acceleration [m/s²], Velocity [m/s], and Displacement [mm peak-to-peak (p-p)]

The force "F" required to give an object of mass, "m" acceleration "A" is;

$$F = mA$$

	SI units	Gravitational units
F : force	[N]	[kgf]
m : mass	[kg]	[kg]
A : acceleration	[m/s ²]	[G]

That is to say, when a mass of 1 kg is accelerated to an acceleration of 1 m/s² the required force is 1 N. Gravitational acceleration "G" equals to 9.8 m/s².

To describe vibration, frequency and vibration level need to be specified. Vibration is a form of movement; with a consequent relationship between acceleration, velocity and displacement. To describe vibration level, any of these units can be used. Here are the relationships between each of the units.

We have an object moving in a sine wave.

The displacement is;

$$D = D_0 \sin \omega t$$

The velocity is obtained by differentiation of the displacement. Therefore

$$V = \frac{dD}{dt}$$

$$V = \omega D_0 \cos \omega t$$

The acceleration is obtained by differentiation of the velocity. Therefore;

$$A = \frac{dV}{dt}$$

$$A = -\omega^2 D_0 \sin \omega t$$

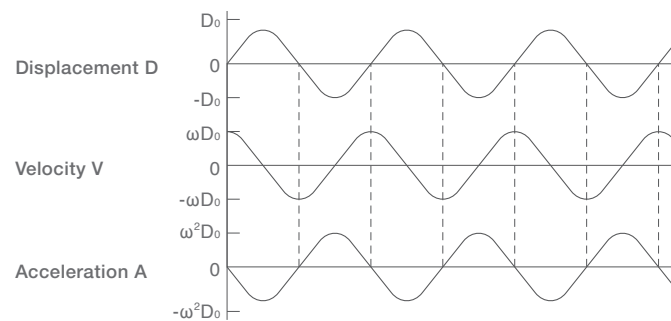
As we substitute

$$\omega = 2 \pi f t$$

We have formulae indicated only in amplitude;

$V = \omega D = 2 \pi f D$	D: Displacement	[m ^{p-p}]
$A = \omega^2 D = (2 \pi f)^2 D$	V: Velocity	[m/s]
	A: Acceleration	[m/s ²]

The following diagram shows waveforms for displacement, velocity and acceleration.



We get the formulae below by transforming the above formulae.

$$f = \frac{A}{2 \pi V}$$

$$A = \frac{V^2}{D}$$

$$V = 2 \pi f D$$

$$D = \frac{A}{(2 \pi f)^2}$$

In the field of vibration test, we use mm p-p for the peak to peak displacement.

Therefore

$$D = \frac{d}{2000}$$

is substituted in to all of the above formulae

$f = \frac{A}{2 \pi V}$	f: Frequency [Hz]
$A = \frac{(2 \pi f)^2 d}{2000}$	A: Acceleration [m/s ²]
$V = \frac{2 \pi f d}{2000}$	V: Velocity [m/s]
$d = \frac{2000 A}{(2 \pi f)^2}$	d: Displacement [mmp-p]

The following is an example

[ex] i) $f = 50$ [Hz], $d = 2$ [mmp-p]

$$V = \frac{2 \pi f d}{2000} = \frac{2 \times \pi \times 50 \times 2}{2000} = 0.314 \text{ [m/s]}$$

$$A = \frac{(2 \pi f)^2 d}{2000} = \frac{4 \times \pi^2 \times 50^2 \times 2}{2000} = 98.7 \text{ [m/s}^2\text{]}$$

ii) $A = 100$ [m/s²], $V = 0.5$ [m/s]

$$f = \frac{A}{2 \pi V} = \frac{100}{2 \times \pi \times 0.5} = 31.8 \text{ [Hz]}$$

$$d = \frac{2000 V^2}{A} = \frac{2000 \times 0.5^2}{100} = 5 \text{ [mmp-p]}$$

Please see the conversion chart (Exchange table) on page 74 for calculation.

About [dB]

We use "dB" as a unit when describing the proportional relationship of physical quantities. Especially, in cases where one value is thousands or millions times a multiple of a reference value, then we use the logarithmic scale "dB" instead of a linear scale. This makes the values more sensible and is an industry standard practice.

"dB" is expressed by the following

$$a = 20 \log \frac{A_1}{A_0} \text{ [dB]}$$

A_1 = Comparison value
 A_0 = Reference value

One million times is ;

$$a = 20 \log \frac{1,000,000}{1} = 120 \text{ [dB]}$$

Not only does dB reduce the number of digits (smaller numbers to handle) but also simplifies calculations. For example, adding 25 dB and 30 dB makes 55 dB but if you do it in a linear way ;

$$25 \text{ [dB]} = 20 \log A \quad A = 10^{\frac{25}{20}} = 17.78$$

$$30 \text{ [dB]} = 20 \log B \quad B = 10^{\frac{30}{20}} = 31.62$$

$$A \times B = 17.78 \times 31.62 = 562.3 = 20 \log 562.3 = 55 \text{ [dB]}$$

Now you see you can use addition instead of multiplication by using "dB". That is to say, it is very easy to calculate by using "dB".

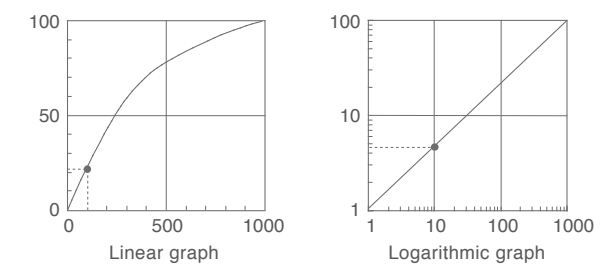
The following is a conversion table for "dB" and multiple.

dB	0	0.1	1	3	6	10	20	30	40	60
Multiple	1	1.01	1.12	1.41	2.0	3.16	10	31.6	100	1000

dB	0	-0.1	-1	-3	-6	-10	-20	-30	-40	-60
Multiple	1	0.99	0.891	0.709	0.501	0.316	0.1	0.0316	0.01	0.001

Use of a logarithmic graph

We often use a logarithmic graph when we need to plot data for vibration testing or other physical phenomena.



On the linear graph, we can read 20 for Y when X is 100. But we can hardly read Y when X is 10 or 1. Whereas on the logarithmic graph, we can read the value even if it is 1/100 or 1/1000 of the maximum value. We use a logarithmic graph for such benefit.

Sine test graph

We often use the graph below when running a Sine vibration test. This is a log-log graph that was discussed above. Asymptotes of constant displacement, velocity and acceleration are shown. Here is an example of an asymptote of constant velocity. From the formulae we learned before

$$A = 2 \pi f V$$

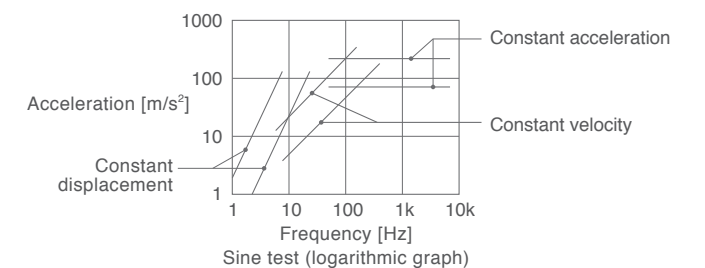
A : Acceleration
 f : Frequency
 V : Velocity

From this equation we can read that acceleration A is increased 10 times when frequency f is also increased 10 times. On the graph below, we see that the acceleration increases to 100 m/s² from 10 m/s² as the frequency increases from 10 Hz to 100 Hz.

In the case of constant displacement

$$A = (2 \pi f)^2 D \quad D : \text{Displacement}$$

The equation shows that acceleration A is increased by 100 (10²) times when the frequency f is increased by 10 times. Acceleration being proportioned to the second power of Displacement. On the graph below, we can read that the acceleration increases to 100 m/s² from 1 m/s² as the frequency increases to 10 Hz from 1 Hz.



The graph shows the asymptotes when velocity or displacement stays constant.

Technical Guidance

For installation of vibration test systems

Vibration insulation for a vibration generator

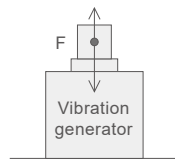
When using a vibration generator, the vibration is transmitted to the building and other facilities through the floor.

Particularly in the frequency range of 2 Hz to 20 Hz, even a small proportion of vibration from the vibration generator can have a large effect on buildings because they have their own resonances in this frequency range.

Therefore, a vibration generator needs a vibration isolation system.

The following shows some examples.

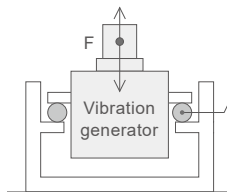
1) No insulation



F: Force

All the force generated by the vibration system is transmitted in to the floor. This may excite resonances in the buildings and other facilities. The vibration generator itself may sometimes jump up and down.

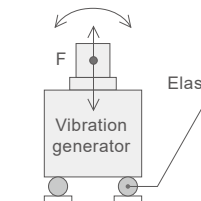
2) Body suspension



Air springs

IMV uses this method of vibration isolation except for the small, compact shaker range. This may limit a shaker system's maximum displacement when the operating frequency is low. See "Limitation of maximum displacement"

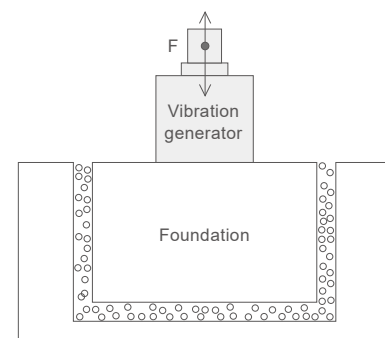
3) Bottom suspension



Elastic objects or air springs

This has a similar effect of vibration isolation but it can also cause lateral motion at low frequency.

4) Isolated foundation

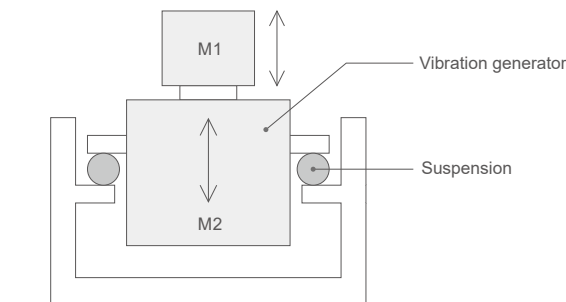


This is the best way of vibration isolation. Generally, the mass of the foundation block should be at least ten times heavier than the rated force of the system. Typically, the mass of the foundation should be twenty times heavier. If you are interested in this method of isolation, please contact IMV.

Limitation of maximum displacement

There are several methods for vibration isolation. All of these ways bring limitations on maximum displacement.

In the case of body isolation, the vibration generator body reacts against the movement of the specimen.



In the case of body isolation, the vibration generator body will be excited by the reaction force. If the shaker excitation frequency is 2-7 Hz, this may coincide with the resonant frequency of the armature suspension system and the body suspension system. The armature and body motion could be almost in "anti-phase" resulting in the absolute value of the available armature displacement becoming severely limited.

Typically only 10 mmp-p displacement is available from a 51 mmp-p rated vibration generator.

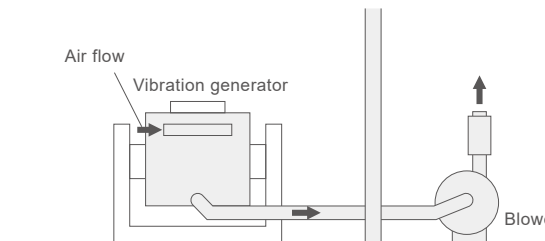
If using an "isolated foundation", the effective mass of the foundation plus vibration generator body could be much heavier than specimen+armature assembly. Therefore, limitation for the available displacement becomes negligible.

Noise control

When the vibration test system is installed, it is necessary to think about the noise. There are several sources of noise such as excitation noise, suction noise (for air-cooled systems), blower noise, blower exhaust noise and cooling fan noise of the power amplifier etc.

The shaker excitation noise might exceed 100 dBA at a typical maximum acceleration of 980 m/s². The suction noise is about 90 dBA, and blower noise + blower exhaust noise is about 80 dBA. However, these figures can differ depending on the shaker model.

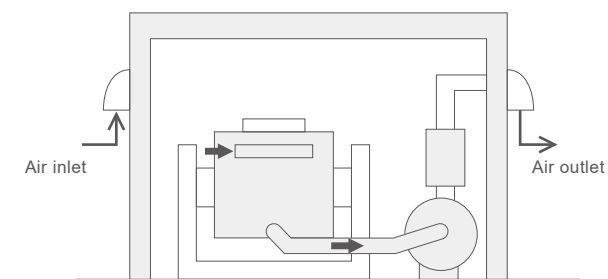
1) Installing the blower outside the room



This is generally a simple method. The blower noise and the blower exhaust noise are reduced in the test area. However, this method doesn't change the suction noise or the excitation noise of the vibration generator. * The blower cannot be installed outdoors.

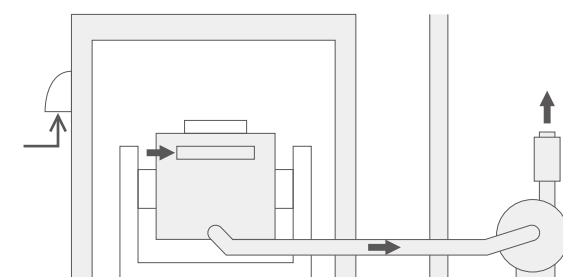
2) Sound proof box

A. Vibration generator and blower



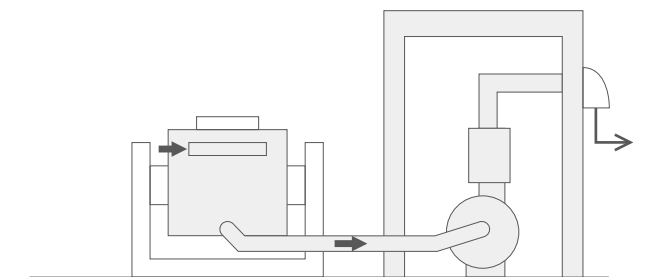
This method reduces the excitation noise and the blower noise. * During the blower is stopped, it is recommended to make treatments to prevent air backflow.

B. Vibration generator only (blower is outside the room)



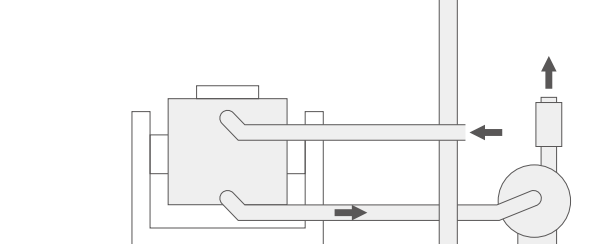
The excitation noise and the air inlet noise are lowered. It is recommended to place the blower outside. * The blower cannot be installed outdoors.

C. Sound proof box only for the blower



The blower noise is reduced. This method doesn't change the suction noise nor the excitation noise of the vibration generator. * During the blower is stopped, it is recommended to make treatments to prevent air backflow.

3) Concentrated suction type



The suction noise of the vibration generator falls by about 5 dBA. The main purpose of concentrated suction is to take air from the outside without using the air in the room to cool the shaker (typically used for clean rooms etc.) * The blower cannot be installed outdoors.

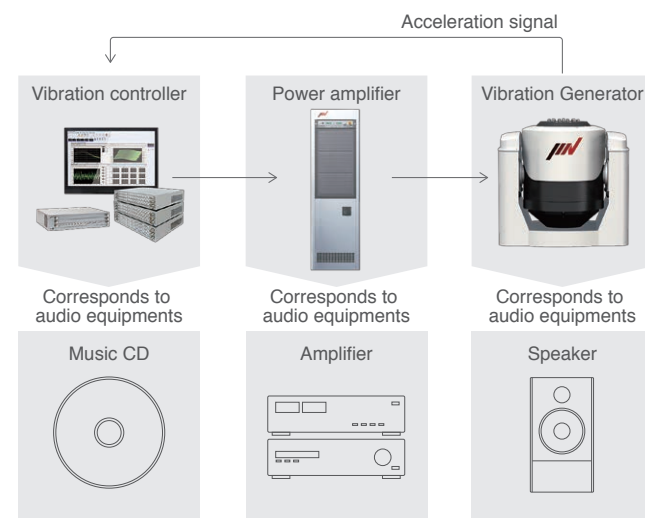
Technical Guidance

Mechanism of vibration test systems

Mechanism of vibration test systems

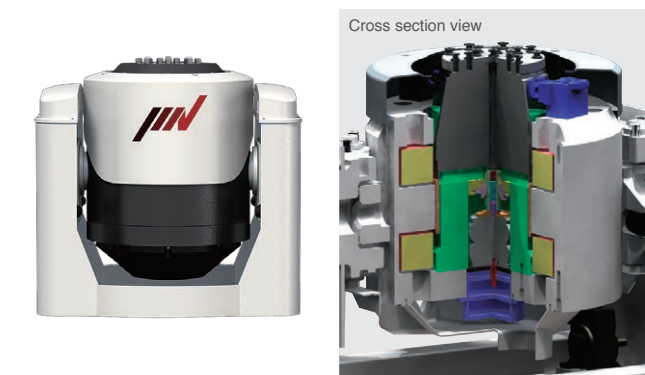
Electrodynamic vibration test systems

The principle is similar to the audio systems where electronic signals from different sources (i.e CDs) are amplified and converted to sound by loud speakers. For the vibration test systems, the vibration generators correspond to the loud speakers of the audio systems. They have the vibration controllers instead of the sound source to drive the vibration generators feeding the electric current through the amplifiers. The difference is that the signals from the transducers mounted on the specimens and/or vibration tables to monitor their motions are fed back to the vibration controllers in order to control the vibrations to meet the requested test conditions.



Vibration generator

The operation principle is based on "Fleming's left hand rule". When an electric current flows in a wire put in a magnetic field, it gets a force perpendicular both to that field and the direction of that current.



Vibration controller

The original waveforms will not be reproduced by just applying the vibration data obtained in the field or from test specimens. The waveforms will be totally deformed due to the characteristics of the amplifiers, combined dynamics of the vibration generators and test specimens. The vibration controllers the equipments to have the vibration generators generate the designated vibration compensating automatically these characteristics or dynamics. All IMV vibration controllers are customised for each of our clients in order to meet their particular needs. "User Friendly" has been always pursued.



Power amplifier

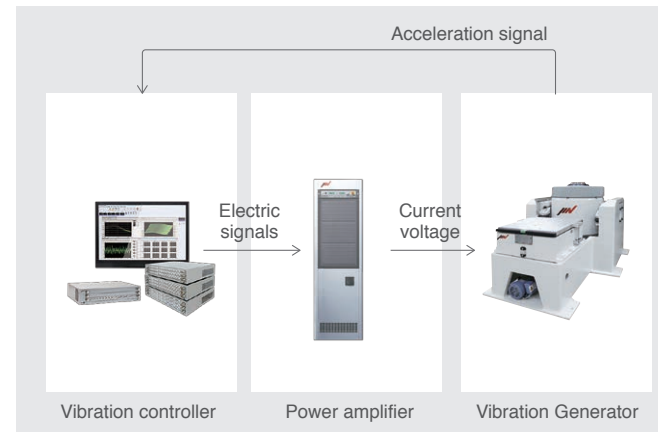
The role of the power amplifier is to feed driving current to the vibration generator converting the small electrical signal generated in the vibration controller to the large current of higher voltage. IMV's power amplifiers employ the switching amplifier system. They use mainly the compact and highly efficient power modules of the top level in this industry to contribute to energy and space saving.



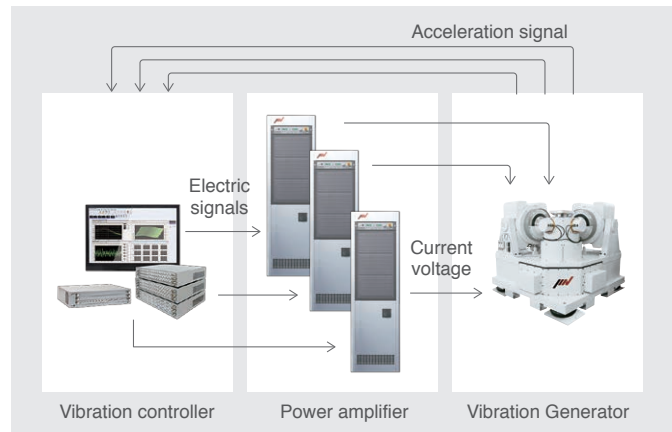
Power module SA-300

Principles of operation

Signal flow, voltage / current supply in single-axis system



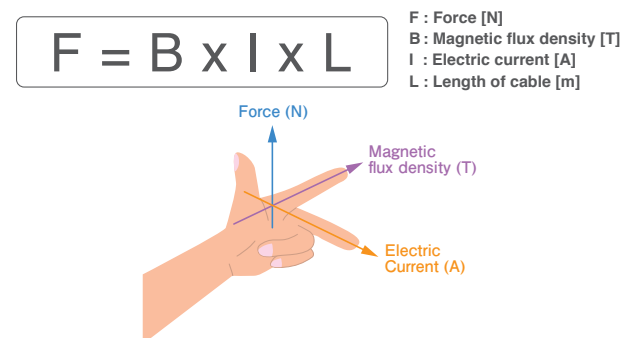
Signal flow, voltage / current supply in multi-axis system



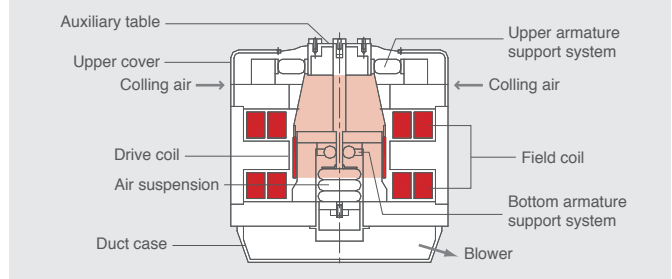
Vibration generator

The operation principle is based on "Fleming's left hand rule".

The formula below represents the Fleming's left hand rule.



Inside of vibration generator (Air cooling method)



Cooling method of vibration generator

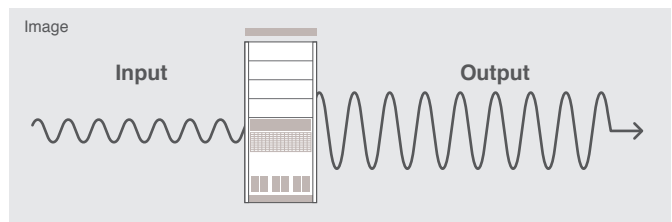
The vibration test system can employ either of two methods to cool : air or water cooling. Each method has its own key features. Selecting a cooling method that meets to your installation requirements based on the key feature as below.

Cooling method	Air cooling	Water cooling
How to cool	Cools the coils by using air from outside. Forces exhaust by blower.	The coils are made of pipe and distilled water is circulated to cool the coils using a heat exchanger and a cooling water.
Key feature	Employs only a blower as cooling equipment. Easy to install.	Operation noise is significantly lower compared to air cooling.
Points to ponder	Duct connection or soundproof treatments may be necessary to reduce suction noise from the vibration generator and exhaust noise from the blower.	A primary cooling water facility is necessary.

Power amplifier

A power amplifier in the system supplies electric power to the vibration generator. The power amplifier generates higher current of higher voltage in response to low power electric signals from the vibration controller.

$$\text{Electric power (VA)} = \text{Electric voltage (V)} \times \text{Electric current (A)}$$



Each component is independently controllable and harmonises each other

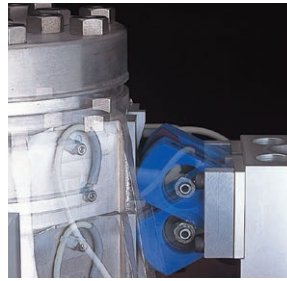
Technical Guidance

Invention with IMV's originality

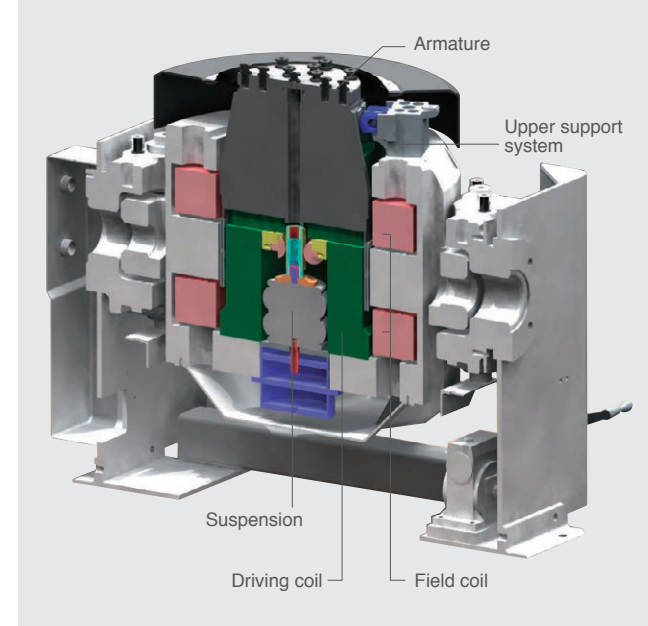
Original technology utilised to improve durability and performance of vibration generators

■ Upper (armature) support system PS guide

Vibration generator receives a dynamic stress by its own vibration. The Parallel Support Guide (PSG) design is a patented one that can support the armature. PSG significantly improves durability, reliability of the system, and quality of vibration at the same time. This compact design provides enough stiffness which exceeds such functions of roller support system and realizes high durability and self-holding supporting system by alternative alignment of gears that have a unique curve.

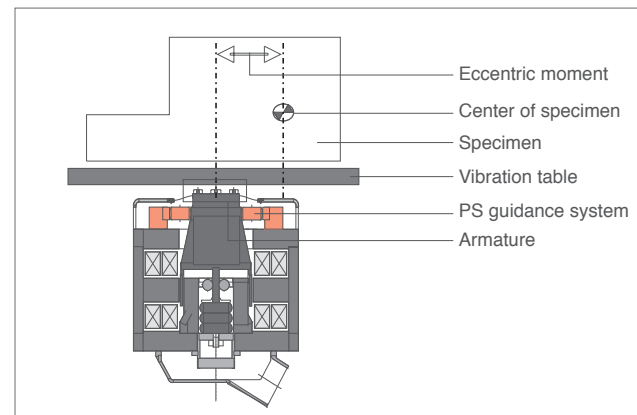


Vibration generator cross section view (image)



■ Large allowable eccentric moment

When the table working surface of the vibration generator is not wide enough to mount the specimen, it must be expanded using some fixture or auxiliary table. Large lateral rigidity of the table guidance systems is important, because it is hard to bring the center of gravity of the specimen on the center line of the vibration table. The larger the specimen is, its importance is increasing. Our PS guidance system (Parallel Support Guide) realizes 130% increase of rigidity over those of the same force range conventional models. It achieved that the specimens whose center of gravity are not located on the center line of the vibration table can be tested being applied higher acceleration.



■ Compatibility of lateral rigidity and waveform regeneration accuracy

Usually lateral rigidity and waveform accuracy conflict each other. PS Guidance system achieved their compatibility. It realizes vibrations of lower waveform distortion with high fidelity.

■ Improvement of durability

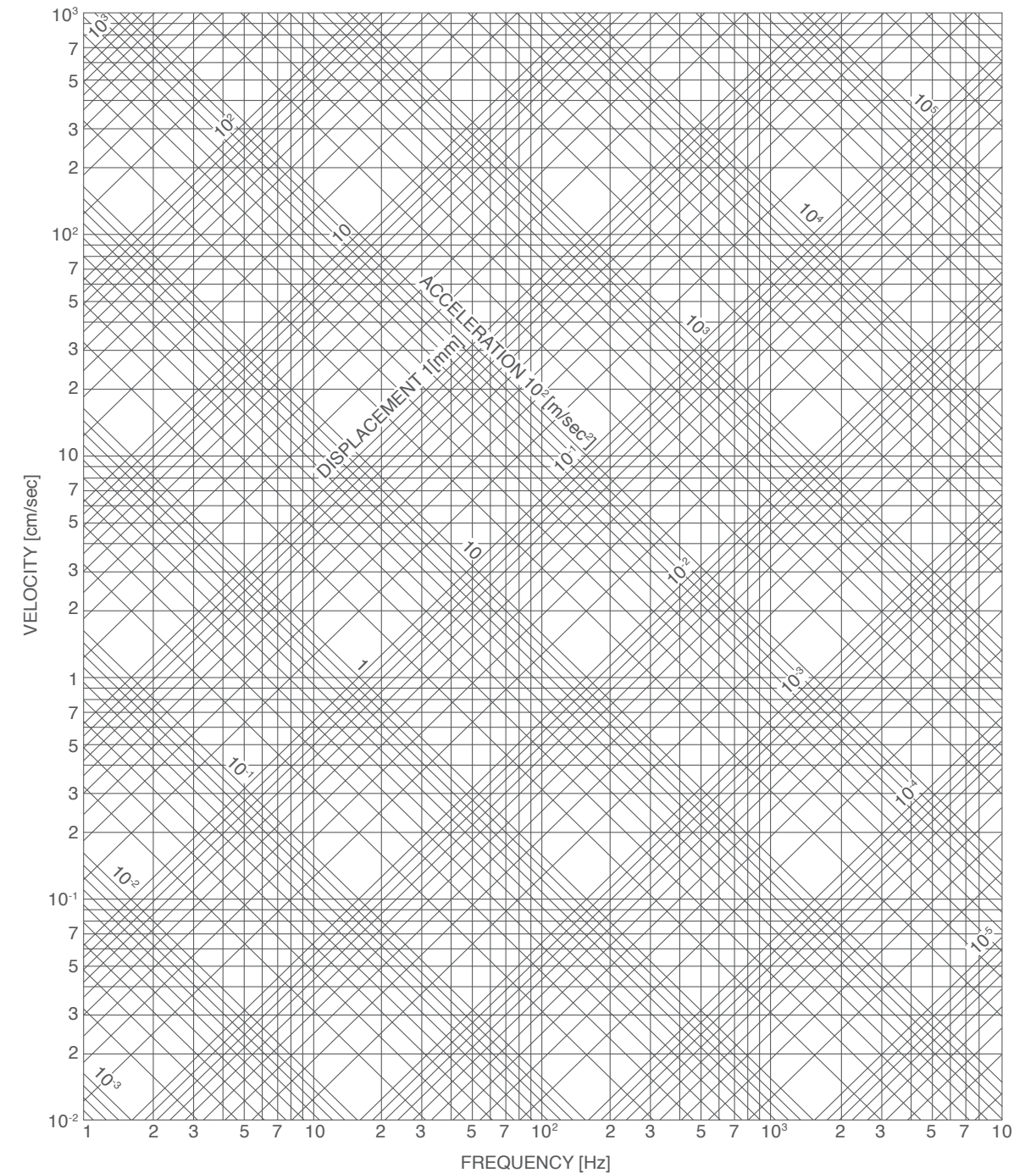
10 times longer (compared to conventional system's) life was achieved to make much longer the interval of maintenance.

■ Flexibility to respond to demand for large displacement tests

Flexibility is provided to respond to demand for 100 mm stroke vibration tests.

Conversion Table

Relationship between frequency, displacement, velocity and acceleration in sine vibration testing



Displacement $D=d$ [mm]

Velocity $V = \frac{2\pi f d}{10}$ [cm/sec]

Acceleration $A = \frac{(2\pi f)^2}{1000} d$ [m/sec²]

f : Frequency [Hz]

Note: D, V and A are in single amplitude

Example

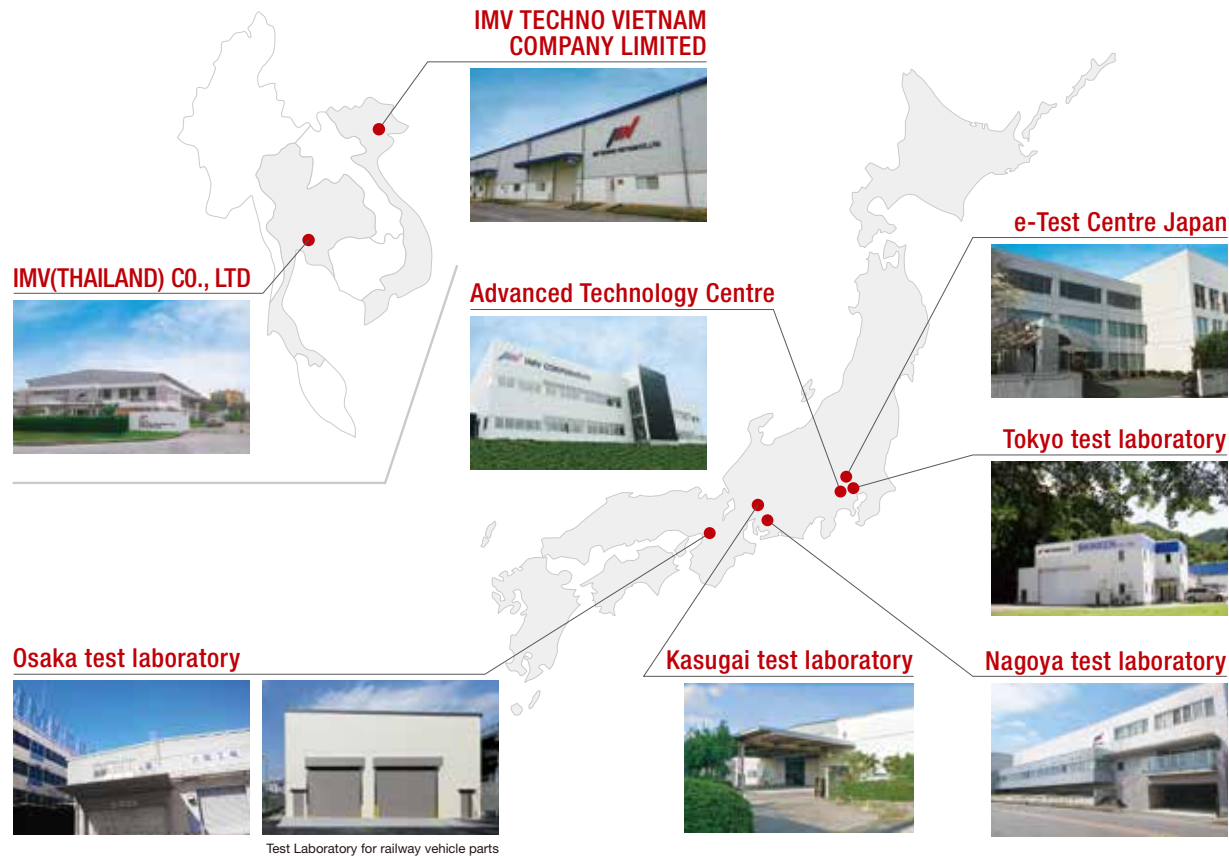
- 1) $f=50$ Hz, $D=1$ mm
 $V=31$ cm/sec, $A=99$ m/sec²
- 2) $f=100$ Hz, $V=100$ cm/sec
 $D=1.6$ mm, $A=630$ m/sec²
- 3) $f=600$ Hz, $A=60$ m/sec²
 $D=0.0042$ mm ($4.2 \mu\text{m}$), $V=1.6$ cm/sec

IMV Test Laboratory Network

IMV's test laboratory network provides customers with full support

IMV offers a full service as the customer's partner of choice

Since 1988, IMV has been pioneering the test laboratory business in Japan. IMV opened six test laboratories in Japan and two overseas. IMV's test experts solve problems with the highest quality and using the most advanced test systems. IMV has worked on over 20,000 test projects.



Certified to ISO/IEC 17025

IMV's test laboratories are authorised and operating under quality control management systems in accordance with the international standard ISO/IEC 17025, which specifies the testing capability and test laboratory calibration.

[Outline of Japanese laboratory]

- (1) Certification number : RTL04240
- (2) Authorisation organisation : Public Interest Incorporated Association the Japan Accreditation Board
- (3) Authorisation date : March 15th, 2016
- (4) Authorised field : Vibration test/shock, test/temperature, cycling test / vibration and temperature cycling test/ISO16750-3 TEST I (engine) and TEST IV (vehicle body)



[Outline of Thai laboratory]

- (1) Certification number : 4784.01
- (2) Authorisation organisation : A2LA
- (3) Authorisation date : June 26th, 2018
- (4) Authorised field : Vibration test (Sine), Vibration test (Random), Shock test, Temperature cycling test, Vibration and temperature cycling test, Temperature test (hot), Temperature test (cold), Temperature and humidity cycling test, Temperature and humidity static test



[Outline of Vietnam laboratory]

- (1) Certification number : VILAS 1284
- (2) Authorisation organisation : Bureau of Accreditation Vietnam (BoA)
- (3) Authorisation date : March 2nd, 2020
- (4) Authorised field : Vibration test (Sinusoidal), Vibration test (Broad band random), Shock test, Dry heat environmental test, Cold environmental test, Change of temperature test, Damp heat environmental test (steady), Damp heat environmental test (cyclic).



e-Test Centre Japan

Focusing on solving problems for our customers, the latest test laboratory brings together Japan's technology for reliability evaluation. Companies complement each other, offering high value-added services such as precise analysis, proposing new test methods, development of new facilities and so on.

- Reliability evaluation test for e-mobility parts such as large-sized motor or inverter of EV/HEV
- Evaluation of large parts such as 100 kg, 1 m is possible while part is being operated
- Various environmental tests such as high stress temperature cycle test or salt spray test
- Ultra-high temperature (900°C) chamber combined vibration test is available
- Other tests performed in conjunction with specialised agencies
- Full security system



4102-142 Miyadera, Iruma, Saitama,
358-0014, Japan
Tel : +81-4-2009-1043
Fax : +81-4-2009-1044
E-mail : info-etcj@imv-corp.com



Advanced Technology Centre for Environmental Testing

To meet the future needs we installed a full range of vibration test systems for battery testing and very large specimens. ATC is a facility that takes into consideration the IT environment and the security of information based on ISO 27001.

- Installed Japan's largest vibration test system, 350 kN
- Lithium-ion battery testing for EV/HEV
- Installed a large earthquake resistance test system capable of reproducing earthquake waves
- High velocity shock test is available
- Full security system



2193-28, Yatsusawa, Uenohara-shi,
Yamanashi, 409-0133, Japan
Tel : +81-554-62-6677
Fax : +81-554-62-6678
E-mail : info-uenohara@imv-corp.com



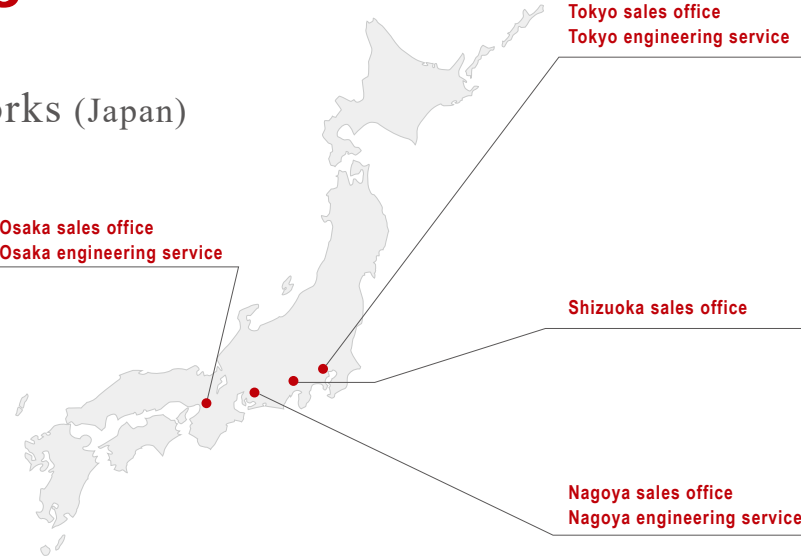
Coverage

Service area

Service networks (Japan)



Osaka sales office
Osaka engineering service



Tokyo sales office
Tokyo engineering service

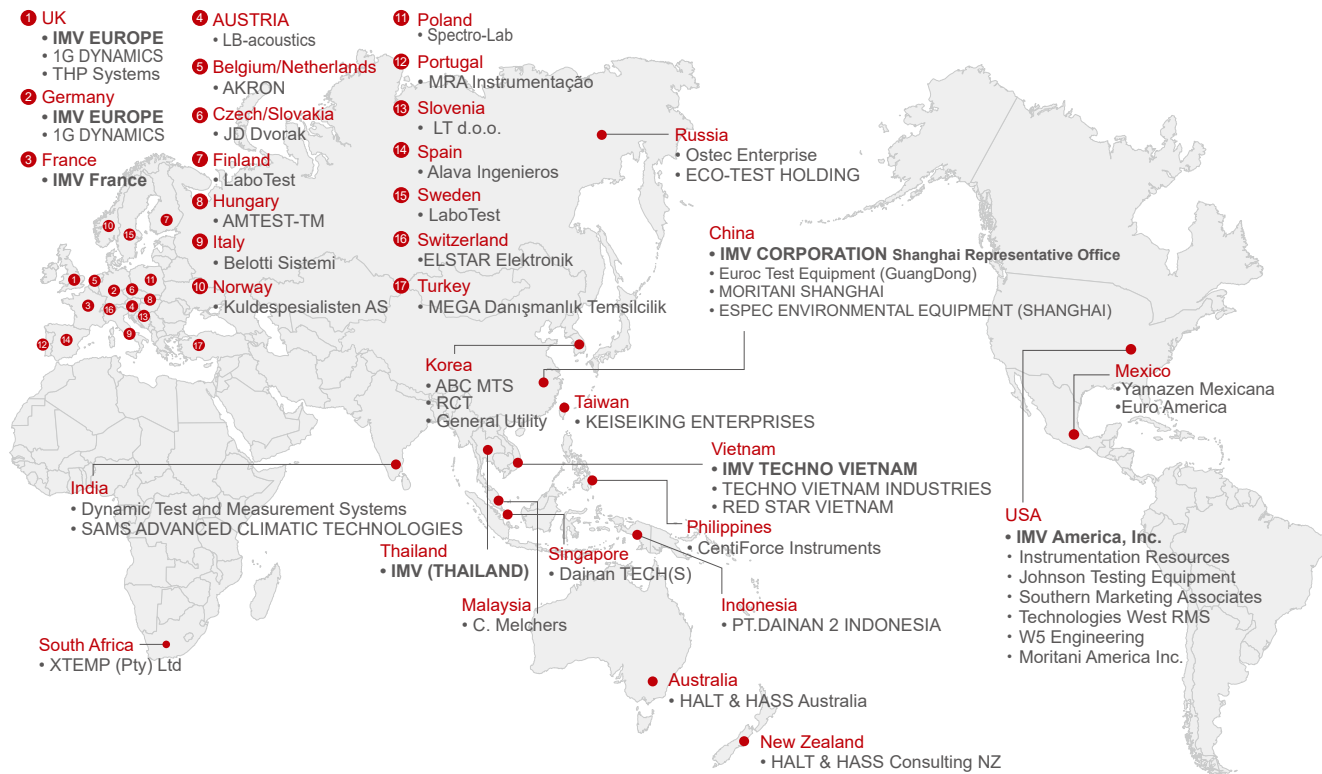


Shizuoka sales office



Nagoya sales office
Nagoya engineering service

Global Networks



Thailand
IMV(THAILAND)CO.,LTD.



UK
IMV EUROPE LIMITED
Manufacturing and
Demonstration Centre



Germany
IMV EUROPE LIMITED
German Sales Office



China
IMV CORPORATION
Shanghai Representative
Office



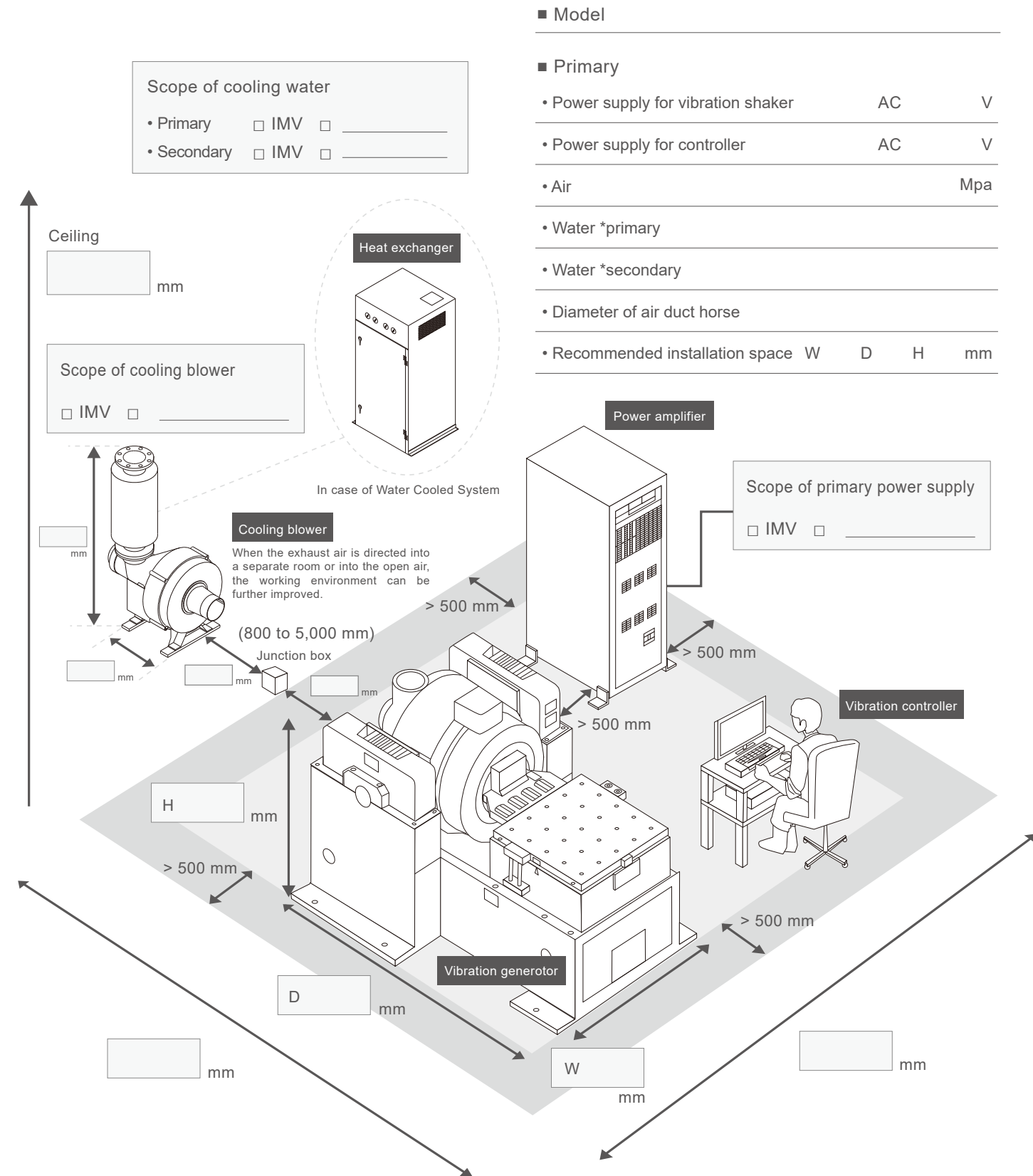
America
IMV America, Inc.



Vietnam
IMV TECHNO VIETNAM
COMPANY LIMITED

System Layout

Instillation Example



*Room layout can be changed to suit the customer's needs.

